

SAMSUNG



SAMSUNG DIGITall
everyone's invited.™

Samsung Telecommunications America
1130 East Arapaho Road
Richardson, TX 75081
Telephone: 1-800-SAMSUNG
Tech Support: 1-888-987-HELP (4357)
www.samsungusa.com/wireless

GH68-03235A Rev.1.0

User Guide

SAMSUNG DIGITall
everyone's invited.™

SGH V205

Contents

| | |
|---|-----------|
| Important Safety Precautions | 7 |
| Unpacking | 9 |
| Your Phone | 10 |
| Phone Layout | 10 |
| Display..... | 13 |
| Service Light..... | 16 |
| Getting Started | 17 |
| Installing the SIM Card..... | 17 |
| Charging a Battery | 19 |
| Switching the Phone On/Off | 21 |
| Using the Holster..... | 22 |
| Call Functions | 23 |
| Making a Call | 23 |
| Adjusting the Volume..... | 25 |
| Answering a Call..... | 26 |
| Viewing Missed Calls | 27 |
| Quickly Switching to Silent mode | 29 |
| Selecting Functions and Options | 30 |
| Example: Setting the Display Language | 32 |
| Phonebook | 34 |
| Storing a Number with a Name..... | 34 |
| Using Phonebook Entry Options | 36 |
| Searching for a Number in the Phonebook..... | 38 |
| Editing a Caller Group | 40 |
| Speed-Dialing | 41 |
| Checking the Memory Status..... | 42 |
| Entering Text | 43 |
| Changing the Text Input Mode | 44 |
| Using the T9 Mode..... | 45 |
| Using the Upper/Lower-Case Character Mode | 46 |
| Using the Symbol Mode | 48 |
| Using the Number Mode | 48 |

* Some of the contents in this manual may differ from your phone, depending on the software installed or your service provider.

* Licensed under U.S patent no.4,558,302 and foreign counterparts.

| | | | |
|---|-----------|---|------------|
| Options During a Call | 49 | Camera | 81 |
| Putting a Call on Hold | 49 | Take and Send (<i>Menu 4.1</i>) | 81 |
| Switching the Microphone Off (Mute) | 50 | New Photo (<i>Menu 4.2</i>) | 82 |
| Muting/Sending Key Tones | 51 | My Photos (<i>Menu 4.3</i>) | 82 |
| Searching for a Number in the Phonebook | 51 | Sound Settings | 84 |
| Using the SMS Service | 52 | Ring Tone (<i>Menu 5.1</i>) | 84 |
| Answering a Second Call | 52 | Ring Volume (<i>Menu 5.2</i>) | 84 |
| Making a Multiparty Call | 53 | Alert Type (<i>Menu 5.3</i>) | 85 |
| Using the Menus | 55 | Keypad Tone (<i>Menu 5.4</i>) | 85 |
| Accessing Menu Functions by Scrolling | 55 | Message Tone (<i>Menu 5.5</i>) | 86 |
| Accessing Menu Functions by Using Shortcuts | 56 | Extra Tones (<i>Menu 5.6</i>) | 87 |
| List of Menu Functions | 56 | Phone Settings | 88 |
| Text Messages | 61 | Infrared Activate (<i>Menu 6.1</i>) | 88 |
| Inbox (<i>Menu 1.1</i>) | 61 | My Settings (<i>Menu 6.2</i>) | 89 |
| Outbox (<i>Menu 1.2</i>) | 62 | Greeting Message (<i>Menu 6.3</i>) | 90 |
| Write New (<i>Menu 1.3</i>) | 64 | Own Number (<i>Menu 6.4</i>) | 90 |
| Templates (<i>Menu 1.4</i>) | 66 | Language (<i>Menu 6.5</i>) | 91 |
| Settings (<i>Menu 1.5</i>) | 67 | Security (<i>Menu 6.6</i>) | 91 |
| My Objects (<i>Menu 1.6</i>) | 68 | Display Settings (<i>Menu 6.7</i>) | 94 |
| Memory Status (<i>Menu 1.7</i>) | 69 | Extra Settings (<i>Menu 6.8</i>) | 96 |
| Voice Mail (<i>Menu 1.8</i>) | 69 | Short Cut (<i>Menu 6.9</i>) | 97 |
| Broadcast (<i>Menu 1.9</i>) | 70 | Reset Settings (<i>Menu 6.10</i>) | 97 |
| Picture Messages | 72 | Organizer | 98 |
| Inbox (<i>Menu 2.1</i>) | 72 | Calendar (<i>Menu 7.1</i>) | 98 |
| Outbox (<i>Menu 2.2</i>) | 74 | To Do List (<i>Menu 7.2</i>) | 100 |
| Write New (<i>Menu 2.3</i>) | 75 | Time & Date (<i>Menu 7.3</i>) | 103 |
| Delete All (<i>Menu 2.4</i>) | 77 | Alarm (<i>Menu 7.4</i>) | 104 |
| Setup (<i>Menu 2.5</i>) | 77 | Calculator (<i>Menu 7.5</i>) | 105 |
| Call Records | 78 | Currency Exchange (<i>Menu 7.6</i>) | 106 |
| Missed Calls (<i>Menu 3.1</i>) | 78 | Network Services | 107 |
| Incoming Calls (<i>Menu 3.2</i>) | 78 | Call Forwarding (<i>Menu 8.1</i>) | 107 |
| Outgoing Calls (<i>Menu 3.3</i>) | 79 | Call Waiting (<i>Menu 8.2</i>) | 109 |
| Delete All (<i>Menu 3.4</i>) | 79 | Network Selection (<i>Menu 8.3</i>) | 110 |
| Call Time (<i>Menu 3.5</i>) | 79 | Caller ID (<i>Menu 8.4</i>) | 111 |
| | | Band Selection (<i>Menu 8.5</i>) | 112 |

| | |
|---|------------|
| Funbox | 113 |
| Games (<i>Menu 9.1</i>)..... | 113 |
| T-Zones (<i>Menu 9.2</i>)..... | 113 |
| Downloads (<i>Menu 9.3</i>)..... | 113 |
| Solving Problems | 115 |
| Access Codes | 118 |
| Phone Password | 118 |
| PIN..... | 119 |
| PUK..... | 119 |
| PIN2..... | 120 |
| PUK2 | 120 |
| Health and Safety Information | 121 |
| Exposure to Radio Frequency (RF) Signals | 121 |
| Precautions When Using Batteries..... | 124 |
| Road Safety..... | 126 |
| Operating Environment | 128 |
| Potentially Explosive Atmospheres | 130 |
| Emergency Calls..... | 131 |
| Other Important Safety Information | 132 |
| Care and Maintenance..... | 133 |
| Acknowledging Special Precautions and the FCC and Industry Canada Notice | 135 |
| Glossary | 140 |
| Index | 144 |



Important Safety Precautions

Read these guidelines before using your wireless phone. Failure to comply with them may be dangerous or illegal. For more detailed safety information, see "Health and Safety Information" on page 121.

Road Safety at All Times

Do not use a hand-held phone while driving; park the vehicle first.

Switching Off When Refueling

Do not use the phone at a refueling point (service station) or near fuels or chemicals.

Switching Off in Aircraft

Wireless phones can cause interference. Using them in aircraft is both illegal and dangerous.

Switching Off in Hospitals

Switch off your phone near medical equipment. Follow any regulations or rules in force.

Interference

All wireless phones may be subject to interference, which could affect their performance.

Special Regulations

Meet any special regulations in force in any area and always switch off your phone whenever it is forbidden to use it, or when it may cause interference or danger (in a hospital for example).

Radio Frequency Exposure

The design of this phone complies with FCC (of the U.S. Government) requirements relating to radio frequency (RF) exposure. To maintain compliance with these requirements, use only Samsung-supplied or approved accessories. Use of non-approved accessories may violate the requirements.

Sensible Use

Use only in the normal position (held to the ear). Avoid unnecessary contact with the antenna when the phone is switched on.

Accessories and Batteries

Use only Samsung-approved accessories and batteries.

Qualified Service

Only qualified service personnel may install or repair your phone.

Unpacking

Your package contains the following items.



Handset



Travel Adapter



Batteries



Hand Strap



User's Manuals



Ear-microphone



Holster

In addition, you can obtain the following accessories for your phone from your local Samsung dealer:

- Ear-microphone
- Simple hands-free kit
- Standard/slim batteries
- Cigarette lighter adapter
- Data link cable

Your Phone

Phone Layout

The following illustrations show the main elements of your phone.

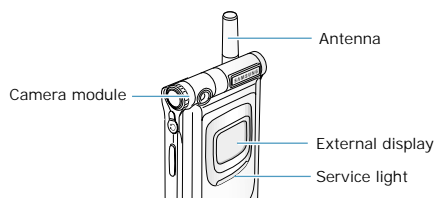
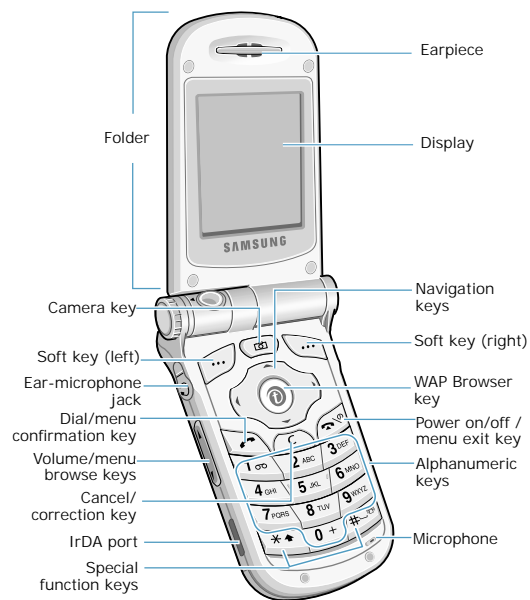

Key Description



In menu mode, scroll through the menu options and Phonebook memory.

In idle mode, allow you to access your favourite menu options directly; for more information on shortcuts, see page 97.



In menu mode, return to the previous menu level and select the current menu level respectively.

When entering text, move the cursor left and right respectively.

In idle mode, allow you to access your favourite menu options directly; for more information on shortcuts, see page 97.



(soft keys)

Perform the functions indicated by the text above them (on the bottom line of the display).



In idle mode, quickly accesses the **Camera** menu to allow you to use the camera on your phone.



In idle mode, quickly launches the WAP (Wireless Application Protocol) browser.



Deletes characters from the display.

In menu mode, returns to the previous menu level.

Key Description (continued)



Makes or answers a call.

When held down in idle mode, recalls the last number dialed or received.

In menu mode, selects a menu function or stores information that you have entered (such as a name) in the phone or SIM memory.



Ends a call. Also switches the phone on and off when held down.

In menu mode, cancels your input and returns to idle mode.



When held down in idle mode, quickly accesses your voice mail.



Enter numbers, letters and some special characters.



Enter special characters.



Perform various functions.



(on the side of the phone)

During a call, adjust the earpiece volume.

In idle mode, adjust the key volume.

In menu mode, scroll through the menu options and Phonebook memory.

Display





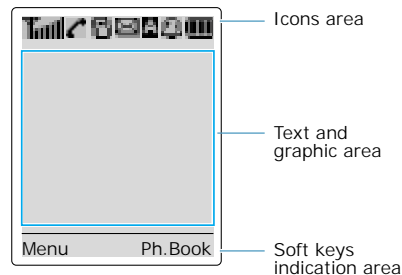





Display Layout

The display has three areas.



| Area | Description |
|--------------|---|
| First line | Displays various icons (see page 14). |
| Middle lines | Display messages, instructions and any information that you enter (number to be dialed, for example). |
| Last line | Shows the functions currently assigned to the two soft keys. |

Icons

| Icon | Description |
|--|--|
|  | Shows the received signal strength. The greater the number of bars, the better the signal. |
|  | Appears when a call is in progress. |
|  | Appears when the silent mode is active or you set the Alert Type menu option (Menu 5.3), so that the phone vibrates when you receive a call; for further details, see page 85. |
|  | Appears when a new text message is received. |
|  | Appears when a new voice mail message is received. |
|  | Appears to indicate the current text input mode when you are entering text. |
|  | Appears when you set an alarm. |
|  | Shows the level of your battery. The more bars you see, the more power you have left. |
|  | Appears when the IrDA port is active. For details, see page 88. |
|  | Appears when the mute mode is active. |

Backlight

The display is illuminated by a backlight. When you press any key or open the folder, the backlight illuminates. It turns off if no key is pressed within a given period of time, depending on the **Back Light** menu option (**Menu 6.7.2**).

To specify the length of time for which the backlight is active, set the **Back Light** menu option (**Menu 6.7.2**); see page 94 for further details.

You can also set the phone to use the backlight only during a specified period of time, via the **Auto Light** menu option (**Menu 6.7.3**); see page 95 for further details.

External Display

Your phone has an external display on the cover. It indicates that you have an incoming call or a message, and notifies you when you set an alarm at the specified time.

Service Light

The service light is below the external display on the folder cover. It flashes when services are available on the phone.

To activate or deactivate use of the service light, set the **Service Light** menu option (**Menu 6.7.4**); see page 95 for further details.

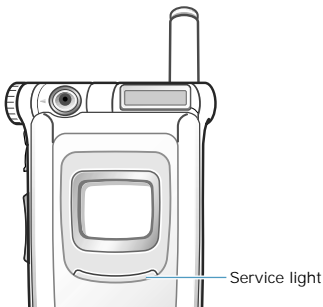

Getting Started

Installing the SIM Card

When you subscribe to a cellular network, you are provided with a plug-in SIM card loaded with your subscription details, such as your PIN, any optional services available and many others.

Important! The plug-in SIM card and its contacts can be easily damaged by scratches or bending, so be careful when handling, inserting or removing the card.

Keep all SIM cards out of the reach of small children.

1. If necessary, switch off the phone by holding down the  key until the power-off image is displayed.
2. Remove the battery. To do so:
 - ① Press down the catch above the battery and hold it in this position.
 - ② Slide the battery and lift it away, as shown.

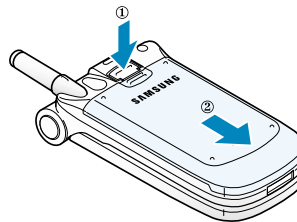

- Slide the SIM card into the SIM card holder so that the holder locks the card in position. Make sure that the notched corner is top left and the gold contacts of the card face into the phone.

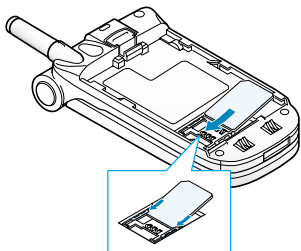

Note: When you need to remove the SIM card, slide it, as shown, and take it out of the holder.

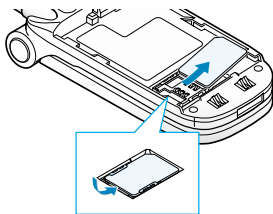

- Place the battery back, taking care to match the tabs on the battery with the grooves on the phone.

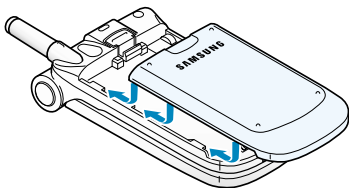

- Slide the battery towards the top of the phone until it clicks into place. Make sure that the battery is properly installed before switching on the power.

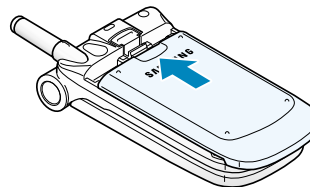

Charging a Battery

Your phone is powered by a rechargeable Li-ion battery. A travel adapter is provided with your phone. Use only approved batteries and chargers. Ask your local Samsung dealer for further details.

The phone can be used while the battery is charging, but this will cause the phone to charge more slowly.

Note: You must fully charge the battery before using your phone for the first time. A discharged battery is fully recharged in approximately 200 minutes.

- With the battery in position on the phone, plug the connector of the travel adapter into the bottom of the phone.

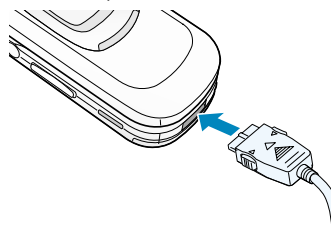

2. Plug the adapter into a standard AC wall outlet.
3. When charging is finished, unplug the adapter from the power outlet and from the phone by pressing the gray tabs on both sides of the connector and pulling the connector out.

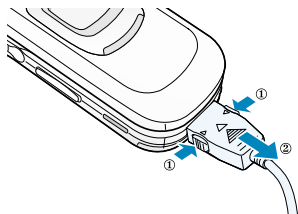

Low Battery Indicator

When the battery is weak and only a few minutes of talk time remain, you will hear a warning tone and a message will be repeated at regular intervals on the display:



When the battery becomes too weak for the phone to operate, it switches off automatically.

Switching the Phone On/Off

1. Open the folder.
2. Hold down the  key until the phone switches on.
3. If the phone asks for a password, enter the password and press the **OK** soft key. The phone password is factory set to "00000000." For further details, see page 118.
4. If the phone asks for a PIN, enter the PIN and press the **OK** soft key. For further details, see page 119.

The phone searches for your network and when it finds the network, the idle screen, illustrated below, appears on each display. Now, you can make or receive a call.

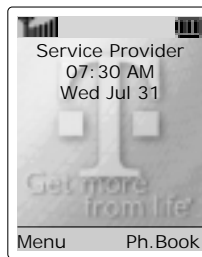

Note: The display language is factory set to English. To change the language, use the **Language** menu option (**Menu 6.5**); for further details, refer to page 91.

5. When you wish to switch the phone off, hold down the  key until the power-off image is displayed.

Using the Holster

The supplied holster allows you to conveniently carry your phone with you.

To attach the phone to the holster:

1. Insert the phone into the slot of the holster and press the top of the phone down until it locks into place.

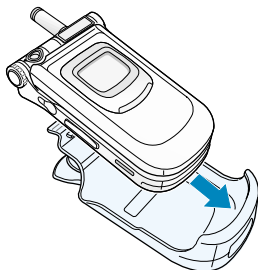

2. Attach the holster to your belt or clothing where it will be convenient to reach and use.

Note: If a hand strap is attached to the phone or there is any obstacle in the hand strap hole, the phone may not be firmly inserted.

To remove the phone from the holster, first press the catch of the holster down to unlock the phone, and then take the phone out of the slot.

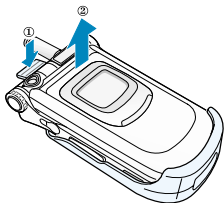



Call Functions

Making a Call



When the idle screen is displayed, enter the area code and phone number, and press the  key.

Note: If you have checked the **Auto Redial** option in the **Extra Settings** menu (**Menu 6.8**), the number is redialed automatically up to ten times when the person does not answer the call or is already on the phone; see page 96 for further details.

Making an International Call

1. Press and hold down the  key. The + character appears.
2. Enter the country code, area code and phone number and press the  key.

Correcting the Number

| To clear... | Press the... |
|-------------------------------|--|
| the last digit displayed |  key. |
| any other digit in the number | (or) key until the cursor is immediately to the right of the digit to be cleared. Press the  key. You can also insert a missing digit simply by pressing the appropriate key. |
| the whole display |  key for more than one second. |





Ending a Call

When you want to finish your call, briefly press the  key.

Redialing the Last Number

The phone stores the numbers you dialed, received or missed if the callers are identified; see “Call Records” on page 78 for further details.

To recall any of these numbers:

1. If you have typed any characters on the display, clear the display by holding down the  key for more than one second.
2. Press the  key to display a list of the last numbers in the order in which the calls were made.
3. Use the  and  keys to scroll through the numbers until the required number highlights.

4. To...

Press the...

dial the number highlighted

 key.

edit the number highlighted



Edit soft key and change the number as required, referring to “Correcting the Number” on page 23 for further details.

Making a Call from the Phonebook

You can store frequently dialed phone numbers with a name in the SIM card or the phone memory, using the Phonebook. You then simply select the required name to recall the associated number. For further details on the Phonebook features, refer to page 34.

Adjusting the Volume

During a call, if you want to adjust the earpiece volume, use the volume keys on the left side of the phone.

Press the  key to increase and the  key to decrease the volume.



In idle mode with the folder open, you can adjust the key volume using these keys.

Answering a Call

When somebody calls you, the phone rings and the following screen appears on each display.

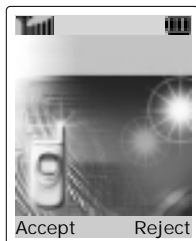

If the caller can be identified, the caller's phone number or name, if stored in your Phonebook, displays.

1. If necessary, open the folder. Press the  key or the **Accept** soft key to answer the incoming call.

If the **Anykey Answer** option in the **Extra Settings** menu (**Menu 6.8**) is checked, you can press any key to answer a call except for the  key and the **Reject** soft key (see page 96).

If the **Active Folder** option in the **Extra Settings** menu (**Menu 6.8**) is checked, you can answer the call simply by opening the folder (see page 96).

Note: To reject an incoming call, press and hold the volume keys on the left side of the phone before opening the folder.

2. End the call by closing the folder or pressing the  key.

Note: You can answer a call while using the Phonebook or menu features.

Viewing Missed Calls



If you are unable to answer a call for any reason, you can find out who called you, provided that this service is available, so that you can call the person back, if necessary.

The number of missed calls is displayed on the idle screen immediately after a call was missed.

To view the missed call immediately:



1. If the phone is closed, open the folder.
2. Press the **View** soft key.

The number corresponding to the most recent missed call displays, if available.

- | | |
|-------------------------------------|---|
| 3. To.... | Press the... |
| scroll through the missed calls |  or  key. |
| call the number displayed |  key. |
| edit or delete a missed call number | Select soft key (see below). |



Editing a Missed Call Number

Note: If the number corresponding to the missed call is not available, the **Edit Number** option is not displayed.

1. Press the **Options** soft key.
2. Press the  or  key to highlight the **Edit Number** option.

3. Press the **Select** soft key.
4. Change the number as required.
5. **To...** **Press the...**
 call the number  key.
 store the number **Save** soft key and enter
 the name and location
 required (for further details,
 refer to page 34).

Deleting a Missed Call



1. Press the **Options** soft key.
2. If necessary, press the  or  key to highlight the **Delete** option.
3. Press the **Select** soft key.

You can press the  key at any time to exit the Missed Call feature.

Note: You can access the Missed Call feature at any time by selecting the **Missed Calls** menu option (**Menu 3.1**); for further details, see page 78.



Quickly Switching to Silent mode

The silent mode is convenient when discretion is required and you wish to stop the phone from making any noise, in a theatre for example.



In idle mode, to switch your phone quickly to silent mode, simply press and hold down the  key until the "Silent Mode" message and vibration icon () are displayed.

In silent mode, your phone changes the sound settings as follows.

| Option | New Setting |
|---------------------------------|-------------|
| Alert Type (Menu 5.3) | Vibration |
| Keypad Tone (Menu 5.4) | OFF |
| SMS Tone (Menu 5.5.1) | Light Only |

To exit the silent mode and reactivate the previous sound settings, press and hold the  key again until "Exit Silent Mode" appears. The vibration icon () is no longer displayed.

Selecting Functions and Options

Your phone offers a set of functions that allow you to customize your phone. These functions are arranged in menus and sub-menus, accessed via the two soft keys marked  and . Each menu and sub-menu allows you to view and alter the settings of a particular function.

The roles of the soft keys vary according to the current context; the label on the bottom line of the display just above each key indicates its current role.

Example:



Press the left soft key to access the main menu mode.

Press the right soft key to access the Phonebook feature.

To view the various functions/options available and select the one required:

1. Press the appropriate soft key.

2. **To...**

Press the...

select the:



Select soft key or the  key.

- function displayed



or

- option highlighted



view the next function or highlight the next option in a list

 key or  key on the left side of the phone.

move back to the previous function or option in a list

 key or  key on the left side of the phone.

move back up one level in the structure

 key,  soft key or  key.

exit the structure without changing the settings

 key.

In some functions, you may be asked for a password or PIN. Enter the required code and press the **OK** soft key.

Example: Setting the Display Language

1. When the idle screen is displayed, press the **Menu** soft key to access the menus.

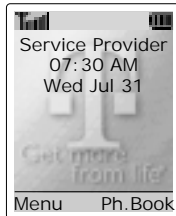

2. Scroll through the menus until you reach the **Phone Settings** menu, by pressing the **▲** or **▼** key.

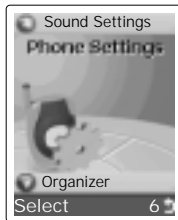

3. To select the **Phone Settings** menu, press the **Select** soft key or the **►** key.

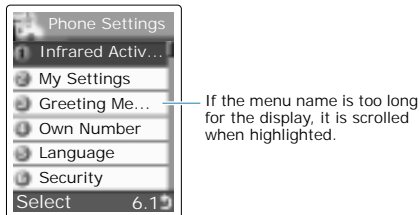

4. Scroll through the sub-menus until you reach the **Language** sub-menu, by pressing the **▲** or **▼** key.

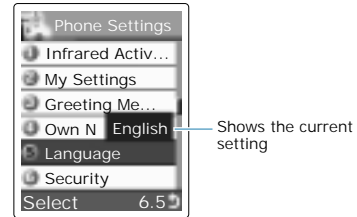

5. To view the languages available, press the **Select** soft key or the **►** key. The current setting is highlighted.

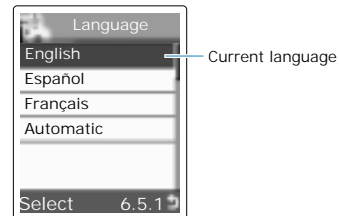

6. Scroll through the list of languages until the appropriate one is highlighted, by pressing the **▲** or **▼** key.
7. Press the **Select** soft key or the **►** key to confirm your selection.
8. Press the **⏪** or **⏩** key twice to exit the menu structure.

Phonebook

You can store phone numbers and their corresponding names in the memory of your SIM card. In addition, you can store up to 500 numbers in the phone memory. The SIM card and phone memories, although physically separate, are used as if they were a single entity, which is called the Phonebook.

Storing a Number with a Name

There are two ways to store a number:





- Using the **Save** soft key in idle mode
- Using the **New Entry** option in the Phonebook menu

Storing a Number in Idle mode

As soon as you start to enter a number, **Save** appears above the left soft key to allow you to store the number in the Phonebook.

1. Key in the number to be stored.

Note: If you make a mistake while entering a number, correct it using the  key. For further details, refer to page 23.

2. When you are sure that it is correct, press the **Save** soft key.
3. Select an icon to identify the category of number to be stored. Three categories are available:  (mobile phone number),  (office number) and  (home number). To select the category, press the ( or ) key, followed by the **Select** soft key.

4. Enter a name and press the **OK** soft key.

The maximum length of a name depends on your SIM card. For information on how to enter characters, see page 43.

5. Press the right soft key, labeled **To Card** or **To Phone** to switch between the phone and card memories.



Note: If you change phones, any numbers stored in your SIM card memory will automatically be available with the new phone, whereas any numbers stored in the phone memory must be restored.

6. Press the **OK** soft key to store the name and number.

After storing, the phone displays the Phonebook entry or name just created.

- | | |
|---------------------------|--|
| 7. To... | Press the... |
| use the entry options | Options soft key. |
| return to the idle screen |  key. |

Storing a Number Using the Phonebook Menu

1. When the idle screen is displayed, press the **Ph.Book** soft key.
2. Scroll to **New Entry** by pressing the  or  key and press the **Select** soft key.

3. Select an icon to identify the category of the number to be stored.
Note: The E-mail icon (✉) is available in this step. It allows you to save an E-mail address instead of a phone number.
4. Continue the procedure from Step 4 on page 35 to store the number.

Using Phonebook Entry Options

While accessing any Phonebook entry, press the **Options** soft key to use the options for the entry.

| To... | Press the... |
|-------------------------------|--|
| select the highlighted option | Select soft key or the › key. |
| highlight a different option | ▲ or ▼ key until the required option highlights. |

The following options are available:

Paste: allows you to paste the selected number into normal dialing mode.

Use this option to dial a number similar to one in the Phonebook, a different extension in the same office, for example.

Use the **☎** key to change the number as required; refer to page 23 for further details. When you are ready to dial, press the **☎** key.

Edit: allows you to edit the Phonebook entry.

Select **One Entry** to change one number in the selected name. If you change the name, the number is saved separately. Select **All Entry** to change the name of the entry.

Erase: allows you to erase the selected name and number from the Phonebook. You are asked to confirm that you wish to erase the name and number by pressing the **Yes** soft key.

Copy: allows you to copy the selected number to another location. Use this option to store a number similar to one already in the memory; once copied, edit the number and store it in the Phonebook.

Caller Group: allows you to assign the entry to a caller group so that the phone alerts you in a particular way when the corresponding person calls you. Select one of the ten groups available.

To remove an entry from a group, select the **No Group** option.

For more information on how to change caller group properties, see page 40.

Add Entry: allows you to add a new number in a different category (mobile, office, home or E-mail) to the currently selected name. A Phonebook entry or name can contain up to four numbers, one in each category.

Searching for a Number in the Phonebook

After storing numbers in the Phonebook, you can search for them in two ways; by name and by caller group.

Searching for a Number by Name

1. When the idle screen is displayed, press the **Ph.Book** soft key.
2. Press the **Select** soft key when **Search** highlights. You are asked to enter a name.
3. Enter the first few letters of the name that you wish to find.

The Phonebook entries are listed, starting with the first entry matching your input. This entry is also highlighted.

- | | |
|--|---|
| 4. To... | Press the... |
| view the highlighted entry | View soft key. |
| select a different entry | ▲ or ▼ key until the required entry highlights. |
| look for a name starting with a different letter | key labeled with the required letter. |

5. Once you have found the required entry, press the **Call** key to dial the number, or press the **Options** soft key to access the Phonebook entry options; for further details, see page 36.

Searching for a Number by Caller Group

1. When the idle screen is displayed, press the **Ph.Book** soft key.
2. Scroll to **Group Search** by pressing the ▲ or ▼ key and press the **Select** soft key. You are asked to enter a group name.
3. Enter the first few letters of the group name that you wish to find.
The caller groups are listed, starting with the first group matching your input. The group is also highlighted.
4. Scroll to the required group by pressing the ▲ or ▼ key and press the **View** soft key.

The Phonebook entries in the selected caller group are listed.

- | | |
|----------------------------|---|
| 5. To... | Press the... |
| view the highlighted entry | View soft key. |
| select a different entry | ▲ or ▼ key until the required entry highlights. |
6. Once you have found the required entry, press the **Call** key to dial the number, or press the **Options** soft key to access the Phonebook entry options; for further details, see page 36.



Editing a Caller Group

1. When the idle screen is displayed, press the **Ph.Book** soft key.
2. Scroll to **Group Edit** by pressing the \blacktriangle or \blacktriangledown key and press the **Select** soft key.
3. Enter the first few letters of the required group name or scroll through the group list by pressing the \blacktriangle or \blacktriangledown key.
4. When the group you want to edit highlights, press the **Options** soft key.
5. Select each option and change the settings, as required. The following options are available:
 - **Call ring tone:** allows you to select the ring tone to be used when you receive a voice call from a person in the group.
 - **SMS tone:** allows you to select the ring tone to be used when you receive a text message from a person in the group.
 - **Graphic:** allows you to select the graphic icon to be displayed when you receive a voice call from a person in the group.
 - **Group Name:** allows you to assign a name to the group; for further details on how to enter characters, see page 43.
6. When you have finished, press the  or \blacktriangle key.



Speed-Dialing

Once you have stored phone numbers in the SIM card, you can set up to eight speed-dial entries and then dial them easily whenever you want, simply by pressing the associated number key.



Setting Up Speed-Dial Entries

1. When the idle screen is displayed, press the **Ph.Book** soft key.
2. Scroll to **Speed Dial** by pressing the \blacktriangle or \blacktriangledown key and press the **Select** soft key.
3. Select the key,  to , to which you wish to assign the speed-dialing feature, and press the **OK** soft key.

Note: If you have already assigned a number to the key, the **Options** soft key replaces the **OK** soft key. Go to Step 6.
4. Select the required Phonebook entry from the list and press the **View** soft key.
5. Select the required number if the entry has more than one number, by pressing the \blacktriangle or \blacktriangledown key and press the **Select** soft key.
6. Once you have assigned a number to the selected key, The following options are available:
 - **Change:** allows you to assign a different number to the key.
 - **Erase:** allows you to clear the setting so that no number is assigned to the key.

- **Erase All:** allows you to clear the settings for all keys so that no numbers are assigned to any of the keys.
 - **Number:** allows you to view the number assigned to the key.
7. When you have finished, press the  or  key.



Speed-Dialing from the Phonebook

To speed-dial the numbers assigned to keys  to , press and hold down the appropriate key.

Note: Memory location 1 is reserved for your Voice Mail server number.

Checking the Memory Status

You can check how many names and numbers are stored in the Phonebook (card and phone memories) or how many free locations remain.

1. When the idle screen is displayed, press the **Ph.Book** soft key.
2. Select the **Memory Status** option.
3. Press the  or  key to view the number of existing and remaining entries in the card and phone memories.

Entering Text

When using your phone, you will often need to enter text. For example, when storing a name in the Phonebook, creating your personal greeting or scheduling events in your calendar. You can enter alphanumeric characters by using your phone's keypad.

Your phone has the following text input modes:

- **T9 mode**

This mode allows you to enter words with only one keystroke per letter. Each key on the keypad has more than one letter – when you press the  key once, J, K or L may be displayed. The T9 mode automatically compares your keystrokes with an internal linguistic dictionary to determine the correct word, thus requiring far fewer keystrokes than the traditional upper/lower-case character modes.

- **Upper/lower-case character modes**

These modes allow you to enter letters by pressing the key labeled with the required letter once, twice, three or four times until the letter displays.

- **Symbol mode**

This mode allows you to enter symbols, such as punctuation marks.

- **Number mode**

This mode allows you to enter numbers.

Changing the Text Input Mode

When you are in a field that allows characters to be entered, you will notice the text input mode indicator on the display.

Example: When you create a text message

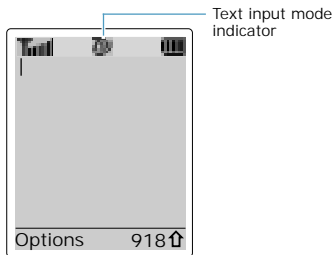

To select the...

Press the  soft key until...

T9 mode

 displays.
See page 45.

Upper-case character mode

A displays.
See page 46.

Lower-case character mode

a displays.
See page 46.

Number mode

1 displays.
See page 48.

Symbol mode

 displays.
See page 48.

Using the T9 Mode



The T9 predictive text input mode allows you to key in any character using single keystrokes. This text input mode is based on a built-in dictionary.



1. When you are in T9 predictive text input mode, start entering a word by pressing keys  to . Press each key only once for one letter.

Example: to enter *Hello* in T9 mode, press , , ,  and .

The word that you are typing appears on the display. It may change with each key that you press.

2. Enter the whole word before editing or deleting the keystrokes.
3. If the word is correct, start entering the next word.

Otherwise, press the ,  or  key to display alternative word choices for the keys that you have pressed.

Example: both *Of* and *Me* have the sequence , . The phone displays the most commonly used choice first.





4. Put a space between each word by pressing the  key.

- To type words not found in the T9 mode, change the text input mode to the upper/lower-case character input mode.

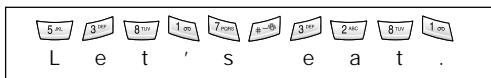
- To enter full stops, hyphens or apostrophes, press the  key. The T9 mode applies grammar rules to ensure that the correct punctuation is used.

Example:  is used twice to display two punctuation marks:



- To change the case in T9 mode, use the  key.
- You can move the cursor by using the  and  keys. To delete letters, press the  key. Press and hold down the  key to clear the display.

Using the Upper/Lower-Case Character Mode





Use the  to  keys to enter your text.

- Press the key labeled with the required letter:
 - Once for the first letter
 - Twice for the second letter
 - And so on
- Select the other letters in the same way.

Note: The cursor moves to the right when you press a different key. When entering the same letter twice or a different letter on the same key, just wait for a few seconds for the cursor to move right automatically, and then select the next letter.

Refer to the table below for more information about the characters available.

| Key | Characters in the Order Displayed | |
|-----|-----------------------------------|--------------------|
| | Upper Case | Lower Case |
| 1 | Space . 1 ! ? & i ÷ § | . @ % _ £ \$ ¥ ¤ § |
| 2 | A B C 2 Ä Å Æ Ç Æ | a b c 2 à á â æ Æ |
| 3 | D E F 3 É Ê Æ | d e f 3 è é Ê |
| 4 | G H I 4 Θ Ψ | g h i 4 ì Ψ |
| 5 | J K L 5 Λ | j k l 5 Λ |
| 6 | M N O 6 Ñ Ø Ö ö | m n o 6 ñ ø ò ö |
| 7 | P Q R S 7 Π Σ Ξ | p q r s 7 β Σ Ξ |
| 8 | T U V 8 Ü ü | t u v 8 ù ü |
| 9 | W X Y Z 9 Ω | w x y z 9 Ω |
| 0 | 0 * # , ; ' " = | / : - + () < > |

- To insert a space, press the  key.
- You can move the cursor by using the  and  keys. To delete letters, press the  key. Press and hold down the  key to clear the display.

Using the Symbol Mode

The Symbol mode enables you to insert symbols in a text message.

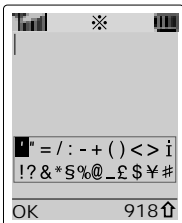

Use the navigation keys to scroll to the desired symbol and then press **OK** soft key to insert the highlighted symbol into your message.

Using the Number Mode

The Number mode enables you to enter numbers in a text message (a telephone number for example). Press the keys corresponding to the required digits before manually switching back to the appropriate text input mode.

Options During a Call

Your phone provides a number of control functions that you can use during a call.

Putting a Call on Hold

You can place the current call on hold whenever you want. You can make another call while you have a call in progress if this service is supported by the network. Of these two calls, one is active and the other is on hold and you can switch between the calls.

To place a call on hold, simply press the **Hold** soft key. You can reactivate the call whenever you want, by pressing the **Unhold** soft key.

To make a call while you have a call in progress:

1. Key in the phone number that you wish to dial or look it up in the Phonebook.
2. Press the  key to dial the second call.
The first call is automatically put on hold.

Or alternatively:

1. Put the current call on hold by pressing the **Hold** soft key. Or press the **Options** soft key and select the **New Call** option.
2. Make the second call in the normal way.

To switch between the two calls, simply press the **Swap** soft key.

The current call is placed on hold and the call on hold is reactivated so that you can continue conversing with the other party.

When you have finished, end each call normally by pressing the  key.

Switching the Microphone Off (Mute)

You can temporarily switch your phone's microphone off, so that the other party cannot hear you.

Example: You wish to say something to another person in the room but do not want the other party to hear you.

To switch the microphone off temporarily:

1. Press the **Options** soft key.
2. If necessary, press the ▼ key to highlight the **Mute** option.
3. Press the **OK** soft key.

The other party can no longer hear you.

To switch the microphone back on:

1. Press the **Options** soft key.
2. If necessary, press the ▼ key to highlight the **Unmute** option.
3. Press the **OK** soft key.

The other party can hear you again.

Muting/Sending Key Tones

These options allow you to turn the key tones off or on. If the **Mute keys** option is selected, your phone does not transmit the key tones. It allows you to press keys without hearing annoying key tones during a call.

Note: To communicate with answering machines or computerized telephony systems, the **Send tones** option must be selected.

Searching for a Number in the Phonebook

You can search for a number in the Phonebook during a call.

1. Press the **Options** soft key.
2. Press the ▼ key to highlight the **Phonebook** option.
3. Press the **OK** soft key.

The Phonebook entries are listed.

4. Enter the name that you wish to find.

If you enter the first few letters of the name, the Phonebook entries are listed, starting with the first entry matching your input. The entry is also highlighted.

5. To view the highlighted entry, press the **View** soft key.

For further details on the Phonebook feature, refer to page 34.

Using the SMS Service

If you receive an SMS (Short Message Service) message during a call, the message icon (✉) flashes on the display. The **Messages** option enables you to use this feature.

Read Messages: allows you to read the messages that you have received.



Write Messages: allows you to write a message.

For further details on the SMS service, refer to page 61.

Answering a Second Call

You can answer an incoming call while you have a call in progress, if this service is supported by the network and you have set the **Call Waiting** menu option (**Menu 8.2**) to **Activate** (see page 109). You will be notified of an incoming call by a call waiting tone.

To answer a call while you have a call in progress:

1. Press the  key to answer the incoming call. The first call is automatically put on hold.
2. To switch between the two calls, press the **Swap** soft key.
To end a call on hold, press the **Options** soft key and select the **End Held Call** option.
3. To end the current call, press the  key.

Making a Multiparty Call



A multiparty call is a network service that allows up to six people to take part simultaneously in a multiparty or conference call. For more information, contact your service provider.

Setting up the Multiparty Call

1. Call the first participant in the normal way.
2. Call the second participant in the normal way. The first call is automatically put on hold.
3. To join the first participant to the multiparty call, press the **Options** soft key and select the **Join** option.
4. To add a new person to the multiparty call, call the person in the normal way, then press the **Options** soft key and select the **Conference** option.

You can add incoming callers by answering the call and pressing **Options**, followed by **Conference**. Repeat as required.

Having a Private Conversation With One Participant

1. Press the **Options** soft key and choose the **Select one** option.
The list of call participants appears.
2. Highlight the required person, by pressing the  or  key, followed by the **Select** soft key or the  key.

3. Select the **Private** option.

Now you can talk privately with that person. The other participants can continue to converse with each other.

4. To return to the multiparty call, press the **Options** soft key and select **Conference**.

All of the multiparty call participants can now hear each other.

Dropping One Participant

1. Press the **Options** soft key and choose the **Select one** option.

The list of call participants appears.

2. Highlight the required person, by pressing the **▲** or **▼** key, followed by the **Select** soft key or the **↶** key.
3. Select **Remove**.

The call is ended with that participant, but you can continue to talk with the other participants.

4. End the multiparty call by closing the folder or pressing the **Ⓜ** key.

Using the Menu

The phone offers a range of functions that allow you to tailor the phone to your needs. These functions are arranged in menus and sub-menus.

The menus and sub-menus can be accessed by scrolling with the navigation keys or by using the shortcuts.

Accessing Menu Functions by Scrolling

1. In idle mode, press the **Menu** soft key to access menu mode.
2. Scroll with the **▲** and **▼** keys to reach the required main menu, **Phone Settings** for example. Press the **Select** soft key or the **↶** key to enter the menu.
3. If the menu contains any sub-menus, **Language** for example, you can access them by scrolling with the **▲** and **▼** keys and pressing the **Select** soft key.

If the menu that you have selected contains further options, repeat the same procedure.



- | | |
|---|---|
| 4. To... | Press the... |
| scroll through the menus | ▲ or ▼ key or use the ▲ and ▼ keys on the left side of the phone. |
| confirm the chosen setting | Select soft key or the ↶ key. |
| return to the previous menu level | ↷ soft key or the ⏪ key. |
| exit the menu without changing the settings | Ⓜ key. |

Accessing Menu Functions by Using Shortcuts

The menu items (menu, sub-menus and options) are numbered and can be accessed quickly by using their shortcut number. The shortcut number is shown in the bottom right next to the **5** soft key on the display. Simply press the **Menu** soft key and key in the required number.

Note: The numbers assigned to each menu option are indicated in the list on the next page. They may not match the menu number on the phone. It depends on the services supported by the SIM card.

Example: Accessing the **Language** option.

1. Press the **Menu** soft key.
2. Press  for **Phone Settings**.
3. Press  for **Language**.

The languages available display directly.

List of Menu Functions

The following illustration shows the menu structure available and indicates the:

- number assigned to each option
- page on which you can find a description of each feature

Note: If you use a SIM AT card that provides additional services, the **SIM AT** menu (**O**) is displayed first when you press the **Menu** soft key to enter menu mode. For further details, refer to your SIM card manual.

1. Text Messages (see page 61)

- 1.1 Inbox
- 1.2 Outbox
- 1.3 Write New
- 1.4 Templates
- 1.5 Settings
 - 1.5.1 Setting 1*
 - 1.5.2 Setting 2*
 - 1.5.3 Setting 3*
 - 1.5.4 Common Setting
- 1.6 My Objects
 - 1.6.1 My EMS Melody
 - 1.6.2 My EMS Picture
 - 1.6.3 My EMS Animation
 - 1.6.4 Delete All
- 1.7 Memory Status
 - 1.7.1 SIM memory
 - 1.7.2 PHONE memory
 - 1.7.3 CB memory
 - 1.7.4 Delete all
- 1.8 Voice Mail
 - 1.8.1 Call Voice Mail
 - 1.8.2 Voice Server Number
- 1.9 Broadcast
 - 1.9.1 Read
 - 1.9.2 Receive
 - 1.9.3 Channel List
 - 1.9.4 Language

2. Picture Messages (see page 72)

- 2.1 Inbox
- 2.2 Outbox
- 2.3 Write New
- 2.4 Delete All
- 2.5 Setup

* Shown only if supported by your SIM card.

3. Call Records (see page 78)

- 3.1 Missed Calls
- 3.2 Incoming Calls
- 3.3 Outgoing Calls
- 3.4 Delete All
 - 3.4.1 Missed Calls
 - 3.4.2 Incoming Calls
 - 3.4.3 Outgoing Calls
- 3.5 Call Time
 - 3.5.1 Last Call
 - 3.5.2 Total Outgoing
 - 3.5.3 Total Incoming
 - 3.5.4 Reset Timers

4. Camera (see page 81)

- 4.1 Take and Send
- 4.2 New Photo
- 4.3 My Photos

5. Sound Settings (see page 84)

- 5.1 Ring Tone
- 5.2 Ring Volume
- 5.3 Alert Type
- 5.4 Keypad Tone
- 5.5 Message Tone
 - 5.5.1 SMS Tone
 - 5.5.2 SMS-CB Tone
- 5.6 Extra Tones
 - 5.6.1 Error Tone
 - 5.6.2 Minute Minder
 - 5.6.3 Connect Tone

6. Phone Settings (see page 88)

- 6.1 Infrared Activate
- 6.2 My Settings
 - 6.2.1 Wallpaper
 - 6.2.2 Menu Style
- 6.3 Greeting Message
- 6.4 Own Number

- 6.5 Language
- 6.6 Security
 - 6.6.1 PIN Check
 - 6.6.2 Change PIN
 - 6.6.3 Phone Lock
 - 6.6.4 Change Password
 - 6.6.5 FDN Mode*
 - 6.6.6 Change PIN2*
- 6.7 Display Settings
 - 6.7.1 Contrast
 - 6.7.2 Back Light
 - 6.7.3 Auto Light
 - 6.7.4 Service Light
 - 6.7.5 Graphic Logo
- 6.8 Extra Settings
 - 6.8.1 Auto Redial
 - 6.8.2 Active Folder
 - 6.8.3 Anykey Answer
- 6.9 Short Cut
- 6.10 Reset Settings

7. Organizer (see page 98)

- 7.1 Calendar
- 7.2 To Do List
- 7.3 Time & Date
 - 7.3.1 Set Time
 - 7.3.2 Set Date
 - 7.3.3 World Time
 - 7.3.4 Time Format
- 7.4 Alarm
- 7.5 Calculator
- 7.6 Currency Exchange

* Shown only if supported by your SIM card.

8. Network Services (see page 107)

- 8.1 Call Forwarding
 - 8.1.1 Forward Always
 - 8.1.2 Busy
 - 8.1.3 No Reply
 - 8.1.4 Unreachable
 - 8.1.5 Cancel All
- 8.2 Call Waiting
 - 8.2.1 Voice Calls
 - 8.2.2 Data Calls
 - 8.2.3 Cancel All
- 8.3 Network Selection
 - 8.3.1 Automatic
 - 8.3.2 Manual
- 8.4 Caller ID
 - 8.4.1 Default
 - 8.4.2 Hide Number
 - 8.4.3 Send Number
- 8.5 Band Selection

9. Funbox (see page 113)

- 9.1 Games
- 9.2 T-Zones
- 9.3 Downloads
 - 9.3.1 Sounds
 - 9.3.2 Pictures

Text Messages





The SMS (Short Message Service) function is a network service and may not be supported by your network. Messages can be sent by text, fax, Email and paging messaging systems, provided that these services are supported by your network. To send text messages by phone, you must obtain the number of the SMS center from your service provider.

When the message icon (✉) appears, you have received new text messages. If the memory is full, an error message is displayed and you cannot receive any new messages. Use the **Delete** option in each message box to delete obsolete ones.

Inbox (Menu 1.1)

This message box is used to store the messages that you have received.

When you enter this menu, the list of messages in the box displays with the senders' phone numbers or names, if available in your Phonebook.

1. Select a message from the list and press the **View** soft key to read the message contents.
2. To scroll through the contents, press the  or  key.
3. To scroll to the previous or next messages, press the  or  key.

While reading a message, you can choose the following options by pressing the **Options** soft key.

Delete: allows you to delete the message.

Send: allows you to resend the message. For further information on how to send a message, see page 64.

Reply: allows you to reply to the sender by sending a text message. You can also change the SMS center number, if required.

Call Back: allows you to call the sender back.

Cut Address: allows you to extract URL or e-mail addresses or a phone numbers from the message text, so that you can save them in your phone's memory.

Edit: allows you to change the message.

Move: allows you to move the message to another memory location, from the SIM card memory to the phone memory or vice versa.

Select Objects: allows you to save the media items, such as sounds or images, from the message into your phone's memory. You can then use the items when writing a message; for details, see page 65.

Outbox *(Menu 1.2)*

This message box is used to store the messages that you have already sent or will send.

When you enter this menu, the list of messages in the box displays with the recipients' phone numbers or names, if available in your Phonebook.

1. Select a message from the list and press the **View** soft key to read the message contents.
2. To scroll through the contents, press the ▲ or ▼ key.
3. To scroll to the previous or next messages, press the ⏪ or ⏩ key.

While reading a message, you can choose the following options by pressing the **Options** soft key.

Delete: allows you to delete the message.

Send: allows you to resend the message. For further information on how to send a message, see page 64.

Cut Address: allows you to extract URL or e-mail addresses or a phone numbers from the message text, so that you can save them in your phone's memory.

Edit: allows you to change the message.

Move: allows you to move the message to another memory location, from the SIM memory to the phone memory or vice versa.

Select Objects: allows you to save the media items, such as sounds or images, from the message into your phone's memory. You can then use the items when writing a message; for details, see page 65.

Write New *(Menu 1.3)*

In this menu, you can write and send a text message.

Note: You can enter up to 918 alphanumeric characters for your message. If you add media items to the message, the number of characters you can enter will be decreased.

Creating a Simple Text Message

1. Create your message.

Note: For more information about entering characters, refer to page 43.

2. When you finish entering your message, press the **Options** soft key. The following options are available:

- **Send Only:** allows you to send the message. The message will be deleted after sending.
- **Save and Send:** allows you to save a copy of the message into the specified memory and then send the message to the destination. You can read the message in your Outbox
- **Save Only:** allows you to save the message into the specified memory so that it can be sent later. You can read the message in your Outbox.
- For information about the **Text Formatting**, **Add Objects**, **Add Templates**, **Add Phonebook**, **Add Bookmark** and **Language** options, see "Creating a Message using the Options" on page 65.

3. Select **Send Only** or **Save and Send**, and press the **Select** soft key.

If you only want to save the message, select **Save Only**. After saving the message, the phone returns to the **Messages** menu.

4. Select the memory where the message is saved and press the **OK** soft key.
5. Enter a destination number and press the **OK** soft key. The message is sent.

Creating a Message using the Options

1. Create your message.

2. Press the **Options** soft key.

3. Select one of the following options by using the **^** and **v** keys and pressing the **Select** soft key.

- **Text Formatting:** allows you to format the style of the text. For the **Size** attribute, the **Normal**, **Large** and **Small** sizes are available. For the **Underline** and **Strikethrough** attributes, select **On** or **Off**. The attributes can be combined.
- **Add Objects:** allows you to add a sound, melody, picture or animation to your message. Select the category of item to be added; **Sound**, **Melody**, **Picture** and **Animation** are available. In each category, you can select the various factory-set items or choose an item received from other sources, such as the Internet or other phones.
- **Add Templates:** allows you to apply one of the preset message templates to the text. Select one of the five messages predefined in the **Templates** menu option (**Menu 1.4**); for further details, see page 66.

- **Add Phonebook:** allows you to add a Phonebook entry in your message. Select one from the list.
 - **Add Bookmark:** allows you to add a web page's address stored in your Favorites list (**Menu 9.2.2**). Select one from the list.
 - **Language:** allows you to change the language to be used in T9 input mode. Select the language to be used.
4. Complete the message, and send or save it by following the procedure from Step 2 on page 64.

Templates *(Menu 1.4)*

Using this menu, you can preset up to nine messages that you use most frequently. Scroll through the template list using the ▲ and ▼ keys. When the message template you want to edit highlights, press the **Options** soft key.

Edit: allows you to write a new message or edit the selected message.

Note: For further information on how to enter characters, refer to page 43.

Send Message: allows you to recall the selected message. Once you have completed the message, you can send, save and send, or simply save it. For details on how to send a message, see page 64.

Delete: allows you to delete the selected message. You are asked to confirm the deletion by pressing the **Yes** soft key.

Settings *(Menu 1.5)*

In this menu, you can set up default SMS information. A setting group is a collection of settings required to send messages. The number of setting groups available depends on the capacity of your SIM card.

Setting x (where **x** is the setting group number): each group has its own sub-menu.

Service Center: allows you to store or change the number of your SMS center required when sending messages. You must obtain this number from your service provider.

Default Destination: allows you to store the default destination number. The number will automatically display on the Destination screen when you create a message.

Default Type: allows you to set the default message type (Text, Fax, Email and Paging). The network can convert the messages into the selected format.

Default Validity: allows you to set the length of time for which your text messages will be stored at the message center while attempts are made to deliver them.

Setting Name: allows you to give a name to the setting group currently being defined.

Common Setting: The following options are available:

Reply Path: allows the recipient of your SMS message to send you a reply message via your message center, if the service is provided by the network.

Delivery Reports: allows you to activate or deactivate the report function. When this function is activated, the network informs you whether or not your message has been delivered.

Bearer Selection: allows you to choose between **GSM** and **GPRS**.

My Objects *(Menu 1.6)*

After saving any sounds or images received in messages into your phone memory, using the **Select Objects** option (see page 62), you can see the items in this menu.

To delete the items while viewing in this menu, press the **Delete** soft key.

You can forward the items to other people by including into a message and/or use them for your ring tone or background them in a image.

Three categories of items are available:

- **My EMS Melody**
- **My EMS Picture**
- **My EMS Animation**

You can delete all of the items using the **Delete All** option (**Menu 1.6.4**).

Memory Status *(Menu 1.7)*

This menu shows how many messages are currently stored in the SIM, phone and CB memories.

You can delete all of the messages in each message box using the **Delete all** option (**Menu 1.7.4**). Select the message box, **Inbox**, **Outbox** or **CB Message**, To delete all of your messages at one time by selecting **All Messages**.

When a confirming message displays, press the **Yes** soft key to confirm.

Voice Mail *(Menu 1.8)*

This menu provides you with a way of accessing your voice mailbox, if provided by your network.

The following options are available:

Call Voice Mail: before using this feature, you must enter the voice server number obtained from your service provider (see menu option **1.8.2**). You can then select this option and simply press the **OK** soft key to listen to your messages.

To quickly connect to the voice server, press and hold down the  key in idle mode.

Voice Server Number: allows you to change the voice mail server number, if necessary.

To...

enter the server number

correct a digit

Press the...

corresponding numeric keys.

 key.

To... **Press the...**

move the cursor to the left/right without clearing the digit

(**<** or **>**) key.

Note: Voice Mail is a network feature. Please contact your service provider for more information.

Broadcast *(Menu 1.9)*

This network service allows you to receive text messages on various topics, such as the weather or traffic. Messages are displayed immediately as they are received, provided that:

- the phone is in idle mode
- the **Receive** option is set to **Enable**
- the message channel is currently active in the channel list

The following options are available:

Read: lets you view the message. **Volatile** displays the messages from the network, but loses its contents as soon as the phone is switched off. Scroll through the message using the **▲** and **▼** keys. While reading a message, press the **Save** soft key to store the message in the **Archive** box for later retrieval.

Receive: allows you to enable or disable the reception of broadcast messages.

Channel List: allows you to indicate the channels from which you wish to receive broadcast messages. The following options are available:

Select: used to enable or disable channels in the list by marking or unmarking them respectively (a check mark is displayed in front of each channel selected).

Add Channel: used to enter the ID and title for a new channel.

Delete: used to remove a channel from the list.

Edit: used to change the ID and title of an existing channel.

Language: allows you to select your preferred language to be used when displaying cell broadcast messages.

Please contact your service provider for more information.

Picture Messages

Multimedia Message Service (MMS) is a messaging service very similar to Short Message Service (SMS). It provides automatic and immediate delivery of personal multimedia messages from phone to phone or from phone to e-mail.

In addition to the familiar text content of text messages, multimedia messages can contain images, graphics, voice and audio clips. An MMS message is a multimedia presentation in a single entry. It is not a text file with attachments.

Using the MMS feature, your phone can receive multimedia messages. You can also send picture messages, which are short messages that contain images, such as your photos or graphics you downloaded from the Internet. This function is available only if it is supported by your service provider. Only phones that offer picture message features can receive and display picture message.

Inbox *(Menu 2.1)*

Viewing a Message When You Receive it

When a new multimedia message comes in, the display shows the text notification along with the sender's number.

1. Press the **View** soft key to view the message.

The display shows brief information about the message, such as the sender's number, the message size and the subject.

If you want to view the message later in the Inbox, press the **Exit** soft key.

2. To scroll through the message, press the **▲** or **▼** key.

While viewing a message, press the **Options** soft key to use the following options:

Retrieve: shows you the message contents.

Delete: deletes the message.

More Information: shows you detailed information about the message.

Viewing a Received Message in the Inbox

When you access the **Inbox** menu option (**Menu 2.1**), the list of multimedia messages you received displays with the senders' phone numbers, if they are available in your Phonebook, or subjects.

1. Select the message and press the **Select** soft key to view the message.
2. To scroll through the message, press the **▲** or **▼** key.

While viewing a message, you can choose the Message options by pressing the **Options** soft key.

If you are viewing a new message, the options are the same as when you view a message as soon as you receive it. See the previous section.

When you are reviewing a message, the following options are available:

Delete: deletes the message.

Reply: allows you to reply to the sender by sending a text or picture message.

Call Back: allows you to call the sender back.

Cut Number: allows you to extract a number from the message text, so that you can call the number or save it in the Phonebook.

Forward: allows you to forward the message to another person.

Save Picture: allows you to save an image from the message into your phone. Photos are stored in the **My Photos** folder (**Menu 4.3**) and other images are in the **Pictures** folder in the **Download** menu (**Menu 9.3**)

Save Sound: allows you to save a sound from the message into the **Sounds** folder in the **Download** menu (**Menu 9.3**).

Outbox *(Menu 2.2)*

When you access this menu option, the list of the picture messages you sent displays.

1. Select the required message and press the **Select** soft key to view the message contents.
2. To scroll through the message, press the ▲ or ▼ key.

While viewing a message, you can choose the following options by pressing the **Options** soft key:

Delete: deletes the message.

Cut Number: allows you to extract a number from the message text, so that you can call the number or save it in the Phonebook.

Send: allows you to resend the message.

Edit Message: allows you to change the message contents, picture or text.

Write New *(Menu 2.3)*

This menu allows you to create a new picture message and then send it to multiple destinations.

Creating and Sending a Picture Message

1. Enter the subject of your message and press the **OK** soft key.
For further details about entering characters, see page 43.
2. Press the **Options** soft key and add the message contents using one of the following options:
 - **Add Text:** Enter the message text and press the **OK** soft key.
 - **Add My Photo:** allows you to add a photo you took using the camera on your phone. Select a photo and press the **View** soft key. Then, press the **Select** soft key to add. For further details about using the camera, see page 81.
 - **Add Picture:** allows you to add a picture stored in the **Pictures** folder in the **Downloads** menu (**Menu 9.3**). Choose a picture and press the **Select** soft key.
 - **Send:** allows you to send the message. Use this option when you finish creating the message.
 - **Save:** saves the message in the Outbox (**Menu 2.2**) for later use. Use this option when you finish creating the message.
3. When the added content displays, press the ▼ key to highlight **Add Here**.

4. Repeat steps 2 and 3 until you finish creating your message.
5. If you want to change the added items, press the **▲** or **▼** key to highlight one and press the **Options** soft key. The following options are available:
 - **Edit**: allows you to change text or replace the image with another.
 - **Delete**: deletes the item from your message.
 - **Send**: allows you to send the message.
 - **Save**: saves the message in the Outbox (**Menu 2.2**) for later use.
6. When you finish creating the message, select **Send** from the options.
7. Choose one of the following options and press the **Select** soft key.
 - **Phone Number**: allows you to enter the desired phone number.
 - **E-mail**: allows you to enter the e-mail address of the recipient to send the message as an e-mail.
 - **Phone Book**: allows you to recall a phone number from your Phonebook.
8. Enter a number or an address, or select a number in the Phonebook. When the correct number or address is displayed, press the **OK** soft key.
9. If you want to send the message to multiple destinations, select **Add Destination** and press the **Select** soft key.

10. Repeat steps 7 to 9. You can enter up to 10 destinations.

If you want to edit the destinations, select one and press the **Select** soft key. You can change or delete it.

11. After entering the destinations, press the **OK** soft key when **Send Message** highlights.

Your phone sends the message.

Delete All *(Menu 2.4)*

You can delete all of the messages in the Inbox or Outbox.

When a confirming message appears, press the **Yes** soft key to confirm.

Setup *(Menu 2.5)*

You can change the default message settings.

To turn a given option on or off, press the **Select** soft key to place or remove a check mark on each option.

The following options are available:

Hide ID: When this option is checked, your phone number is not displayed on the recipient's phone.

Delivery Report: When this option is checked, the network informs you whether or not your message has been delivered.

Read Reply: When this option is checked, your phone sends a request for a reply along with your message to the recipient.

Call Records

In this menu, you can view the:

- missed, incoming or outgoing calls
- length of time of the call you made or received

Note: You can access all of the numbers in the three types of call records by pressing the  key in idle mode.

Missed Calls *(Menu 3.1)*

This option lets you view the last 20 unanswered calls.

The number and name, if available, are displayed, together with the date and time when the call was received. By pressing the **Options** soft key, you can:

- delete the call from the list
- edit the number, if available, and save it in the Phonebook
- make a call to the number

Incoming Calls *(Menu 3.2)*

This option lets you view the last 20 phone calls answered.

The number and name, if available, are displayed, together with the date and time when the call was received. By pressing the **Options** soft key, you can:

- delete the call from the list
- edit the number, if available, and save it in the Phonebook
- make a call to the number

Outgoing Calls *(Menu 3.3)*

This option lets you view the last 20 numbers dialed.

The number and name are displayed, together with the date and time when the call was made. By pressing the **Options** soft key, you can:

- delete the number
- edit the number and save it in the Phonebook
- make a call to the number

Delete All *(Menu 3.4)*

You can delete all of the numbers stored in each call record.

When a confirming message appears, press the **Yes** soft key to confirm.

Call Time *(Menu 3.5)*

This option lets you view the timers for calls made and received.

Note: The actual time invoiced for calls by your service provider may vary, depending on network features, such as rounding-off for billing purposes.

The following timers are available:

Last Call: the length of the last call.

Total Outgoing: the total length of all calls made since the timer was last reset.

Total Incoming: the total length of all calls received since the timer was last reset.

Reset Timers: the option used to reset the call timers; you must first enter the phone password (see page 118) and then press the **OK** soft key.

Camera

Using the camera module built in your phone, you can take pictures of people or events while on the move. Additionally, you can send photos to other people in a picture message or as an e-mail attachment. The camera produces JPG pictures.

Take and Send *(Menu 4.1)*

This menu allows you to take a picture to send the photo as a picture message to other destinations.

Taking a Picture to Send a Message

1. Accessing this menu turns on the camera at the top left of the phone.

You can see the picture to be captured on the display.

2. Adjust the picture by rotating the camera module.



Use the (and) keys to adjust the brightness of the picture.

The ^ and v keys allows you to flip the picture vertically.

3. Press the **Take** soft key to take a picture.
If you want to have the delay time of 10 seconds, press the **After 10s** soft key.
4. Press the **Save** soft key to save the photo.
5. Enter a name for your photo and press the **OK** soft key.
For further details about entering characters, see page 43.
6. Follow the procedures on page 75 to send the photo as a picture message.

New Photo *(Menu 4.2)*

In this menu, you can take a picture and save it.

Accessing this menu turns on the camera at the top left of the phone.

Follow steps 2 to 5 in "Taking a Picture to Send a Message" on page 81.

My Photos *(Menu 4.3)*

This menu allows you to review your photos.

When you access this menu, the latest photo is displayed. Press the **◀** or **▶** key to scroll through the photos.

Pressing the **Multi** soft key shows the photos as thumbnail images on one screen. In thumbnail view mode, use the navigation keys to scroll through the photos. To go back to normal view mode, press the **View** soft key.

Press the **Options** soft key to use the following options:

Send: allows you to send the photo as a picture message. For further details, see page 75.

Wallpaper: allows you to set the photo to be displayed on the idle screen as a background image.

Delete: deletes the photo.

Delete All: deletes all of the photos saved in your phone.

Rename: allows you to change the name of the photo.

Sound Settings

You can use the Sound Settings feature to customize various settings, such as the:

- ring melody, volume and type
- sounds made when you press a key, make an error or receive a message

Ring Tone *(Menu 5.1)*

This option allows you to select the required ring melody.

You can choose between many different melodies. Each time you select a melody, it is played for a few seconds. If you have downloaded any sounds from the Internet or EasyGPRS program or received any ring tone messages, you can view the list in this menu.

Ring Volume *(Menu 5.2)*

This option allows you to adjust the ring volume to one of five levels.

Use the ▲ and ▼ keys or the ▲ and ▼ keys on the left side of the phone.

Alert Type *(Menu 5.3)*

This option allows you to specify how you are to be informed of any incoming calls.

The following options are available:

Light only: only the backlight is switched on; the phone neither rings nor vibrates.

Melody: the phone rings using the ring melody selected via the **Ring Tone** menu option (**Menu 5.1**); see page 84.

Vibration: the phone vibrates but does not ring.

Vibra+Melody: the phone first vibrates three times and then starts ringing.

Keypad Tone *(Menu 5.4)*

This option allows you to select the tone that the keypad generates when you press a key.

The following options are available:

OFF: the phone does not make any sound.

Tone: each key, when pressed, makes a different sound.

Beep: each key, when pressed, makes the same sound.

Message Tone *(Menu 5.5)*

This option allows you to select how the phone informs you that a new message has been received.

SMS Tone

This option allows you to select how the phone informs you that a new SMS message has been received.

The following options are available:

OFF: the phone does not use the SMS tone.

Light Only: the service light on the folder cover flashes.

Vibration: the phone vibrates.

Single Beep: the phone beeps once.

SMS Tone x: the phone uses an SMS tone. You are provided with several SMS tones.

SMS-CB Tone

This option allows you to select how the phone informs you that a new cell broadcast (CB) message has been received.

The following options are available:

OFF: the phone does not use the CB tone.

Light Only: the service light on the folder cover flashes.

Vibration: the phone vibrates.

Single Beep: the phone beeps once.

SMS-CB Tone x: the phone uses a CB tone. You are provided with several CB tones.

Extra Tones *(Menu 5.6)*

You can customize various other tones used by the phone.

| To turn a given tone... | Press the... |
|-------------------------|--|
| on | ON soft key. A check mark is displayed in front of the option. |
| off | OFF soft key. The check mark is no longer displayed. |

The following options are available:

Error Tone: sets whether the phone informs you that you have made a mistake or not.

Minute Minder: sets whether the phone must beep every minute during an outgoing call to keep you informed of the length of your call.

Connect Tone: sets your phone to beep when the person you are calling answers the phone.

Phone Settings

Many different features of your phone can be customized to suit your preferences. All of these features are accessed in the **Phone Settings** menu.

Infrared Activate *(Menu 6.1)*

This feature allows you to send or receive data/fax through the infrared port. To use an infrared connection, you must:

- configure and activate an IrDA-compliant infrared port on your PC
- activate the infrared feature on the phone; the IrDA icon () appears on the top line of the display
- align the IrDA port on the phone with the IrDA port on your computer

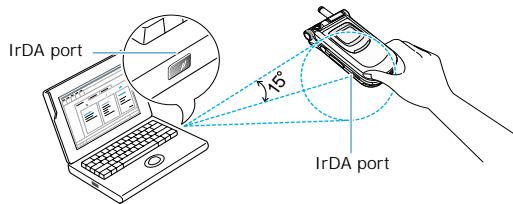

The connection is ready for data transmission.

If there is no communication between your phone and the IrDA-compliant device within 30 seconds of activating the feature, it is automatically deactivated.

Note: For the best performance, use the optional data link cable. You can buy one from your local Samsung dealer.



My Settings *(Menu 6.2)*

You can change the background image and the color of the components in the display according to your preference.

Wallpaper

This option allows you to change the background image (wallpaper) to be displayed in idle mode.

To change the background image:

1. Scroll through the list by pressing the  or  key.

You have various preset images available. If you set a photo as your wallpaper in the **My Photos** menu option (**Menu 4.3**), you can see it by the name of My icon.icn.

2. Press the **Select** soft key when the desired image highlights.

The selected image is displayed.



3. After viewing the image, press the **Select** soft key to display it on the idle screen.

Menu Style

This option allows you to select the menu display style. You can choose between **Film Style** and **Page Style**.

Greeting Message *(Menu 6.3)*

This option allows you to set a greeting message to be displayed briefly when the phone is switched on. When you select this menu, the current message is displayed.

| To... | Press the... |
|----------------------------|--|
| clear the existing message |  key and hold it down until the message is cleared. |
| enter a new message | appropriate alphanumeric keys. |
| change the text input mode |  soft key. |

For further details on how to enter characters, refer to page 43.

Own Number *(Menu 6.4)*

This feature allows you to:

- Assign a name to your own phone number registered on your SIM card
- Edit the name and number

This function is a memory aid, which you can use to check your own phone number if you need to do.

Any changes made here do not in any way affect the actual subscriber number on your SIM card.

Language *(Menu 6.5)*

You can select a display language. When the language option is set to **Automatic**, the language is automatically selected according to the language of the SIM card used.

Security *(Menu 6.6)*

The Security feature enables you to restrict the use of your phone to:

- the people of your choice
- the types of calls of your choice

Various codes and passwords are used to protect the features of your phone. They are described in the following sections (see also pages 118-120).

PIN Check

When the PIN Check feature is enabled, you must enter your PIN each time you switch the phone on. Consequently, any person who does not have your PIN cannot use your phone without your approval.

Note: Before disabling the PIN Check feature, you must enter your PIN.

To change your PIN, refer to the **Change PIN** menu option (**Menu 6.6.2**).

The following options are available:

Disable: the phone connects directly to the network when you switch it on.

Enable: you must enter the PIN each time the phone is switched on.

Change PIN

This feature allows you to change your current PIN to a new one, provided that the PIN Check feature is enabled. You must enter the current PIN before you can specify a new one.

Once you have entered a new PIN, you are asked to confirm it by entering it again.

Phone Lock

When the Phone Lock feature is enabled, the phone is locked and you must enter the 8-digit phone password each time the phone is switched on.

The password is factory set to "00000000." To change the phone password, refer to the **Change Password** menu option (**Menu 6.6.4**) below.

Once the correct password has been entered, you can use the phone until you switch it off.

The following options are available:

Disable: you are not asked to enter the phone password when you switch the phone on.

Enable: you are required to enter the phone password when you switch the phone on.

Change Password

The Change Password feature allows you to change your current phone password to a new one. You must enter the current password before you can specify a new one.

The password is factory set to "00000000." Once you have entered a new password, you are asked to confirm it by entering it again.

FDN Mode

The FDN (Fixed Dial Number) mode, if supported by your SIM card, allows you to restrict your outgoing calls to a limited set of phone numbers.

The following options are available:

Disable: you can phone any number.

Enable: you can only call phone numbers stored in the Phonebook. You must enter your PIN2.

Note: Not all SIM cards have a PIN2. If your SIM card does not, this menu option is not displayed.

To change your PIN2, refer to the **Change PIN2** menu option (**Menu 6.6.6**) below.

Change PIN2

The Change PIN2 feature allows you to change your current PIN2 to a new one. You must enter the current PIN2 before you can specify a new one.

Once you have entered a new PIN2, you are asked to confirm it by entering it again.

Note: Not all SIM cards have a PIN2. If your SIM card does not, this menu option is not displayed.

Display Settings *(Menu 6.7)*

Contrast

This option allows you to adjust the contrast of the display screens to make them lighter or darker.

To adjust the display contrast:

1. Select the required display, **Main LCD** or **Front LCD**, and press the **Select** soft key.
2. Adjust the contrast using the \wedge and \vee keys or the \blacktriangle and \blacktriangledown keys on the left side of the phone.
3. When you are satisfied, press the **OK** soft key to save the selection.

Back Light

You can select whether or not the phone uses the backlight. A marginal increase in standby/talk time can be achieved by turning the backlight off.

The following options are available:

OFF: the backlight is not used.

Short: the backlight comes on when you press a key or receive a call and switches off 10 seconds after the last key is pressed.

Long: the backlight comes on when you press a key or receive a call and switches off 20 seconds after the last key is pressed.

Auto Light

Using this feature, you can specify the time for which the backlight is to be used. This feature helps conserve your battery power.

The following options are available:

Disable: the backlight is used according to the setting in the **Back Light** menu option (**Menu 6.7.2**); see page 94.

Enable: the backlight is used only during the specified period of time. Set the time when the phone will turn on the light and turn it off, using the appropriate number keys.

Service Light

This option allows you to select whether or not the service light on the folder cover is used or in which color it flashes.

Select one from the seven color settings available. When the phone is ready for use, the service light will flash in the appropriate color.

If you do not want to use the service light, select **Off**.

Graphic Logo

This option allows you to display your operator's logo instead of its name.

On: the operator logo stored in your phone is displayed in idle mode; if no logo has been stored, the operator name is displayed.

Off: the operator name is displayed in idle mode.

Extra Settings *(Menu 6.8)*

You can turn the automatic redialing or answering features on or off.

| To turn a feature... | Press the... |
|----------------------|--|
| on | ON soft key. A check mark is displayed in front of the option. |
| off | OFF soft key. The check mark is no longer displayed. |



The following options are available:

Auto Redial: when this option is checked, the phone makes up to ten attempts to redial a phone number after an unsuccessful call.

Note: The interval between two call attempts varies.

Active Folder: when this option is checked, you can simply open the folder to answer a call.

When it is unchecked, you must open the folder and press a key, depending on the setting of the **Anykey Answer** option (see below).









Anykey Answer: when this option is checked, you can answer an incoming call by pressing any key, except the  key, the  key and the **Reject** soft key. To reject the call, press the  key or the **Reject** soft key.

When this option is unchecked, you can only press the  key or **Accept** soft key.

Short Cut *(Menu 6.9)*

The navigation keys can be used as shortcut keys. When held down in idle mode, they allow you to access specific menu options directly.

To assign a shortcut to a key:

1. Select the key to be used as a shortcut key by pressing the  or  key, followed by the **Select** soft key.
 - **Key up** ()
 - **Key down** ()
 - **Key right** ()
 - **Key left** ()
2. Select the menu option to be assigned to the key by pressing the  or  key.

Note: To deactivate a shortcut key, select the **None** option.
3. Press the **Select** soft key to save the selection.

Reset Settings *(Menu 6.10)*

You can easily reset your phone to its default configuration.

1. Select the **Reset Settings** menu option.
2. Enter the 8-digit phone password and press the **OK** soft key.

Note: The password is preset to "00000000." To change this password, refer to page 92.

Organizer

The Organizer feature enables you to:

- view the calendar and organize your schedule
- define a list of things to do
- set the current date and time
- set the alarm so that the phone rings at a specific time (to remind you of an appointment for example)
- use the phone as a calculator for basic mathematical equations or currency exchange operations

Calendar *(Menu 7.1)*

With the Calendar feature, you can:

- consult the calendar
- write memos to keep track of your schedule and trigger an alarm, if necessary

Consulting the Calendar

When you select the **Calendar** menu option (**Menu 7.1**), the calendar is displayed. The following options are available when you press the **Options** soft key.

Search all: displays all memos set, regardless of the day and starting with the oldest. To scroll through the memos, press the **▲** or **▼** key.

Delete all: allows you to delete all memos. You are asked to confirm your action.

Go to date: allows you to jump to a specific date.

Exit: exits the Calendar feature and returns to the idle mode.

Writing a Memo

To write or edit a memo on a specific date:

1. Select the required date in the calendar, using the navigation keys.

Note: To skip to the previous or next month, press the volume keys on the left side of the phone.

2. Press the **Select** soft key.

An empty memo screen is displayed to allow you to enter your memo.

3. Enter your memo and then press the **OK** soft key.

Note: For further details on how to enter characters, refer to page 43.

You are asked if you wish to set an alarm.

4. If you want the alarm to ring on the chosen day, press the **Yes** soft key. Otherwise, press the **No** soft key.
5. If you pressed the **Yes** soft key, set the time for the alarm and press the **OK** soft key.

The color of the date is changed to green to indicate that a memo exists.

Editing a Memo

If you select a day for which a memo already exists, you can press the **Edit** soft key to edit the memo displayed.

Note: For further details about how to enter characters, refer to page 43.

Once you have finished editing the memo, press the **OK** soft key. The following options are then available when you press the **Options** soft key.

Alarm: allows you to set the alarm to ring on the chosen day.

Erase: allows you to delete the memo.

Copy to: allows you to copy the memo to another date and/or time.

Move to: allows you to change the date and/or time of the memo.

To Do List *(Menu 7.2)*

This feature allows you to:

- enter up a list of tasks to be done
- assign a priority and deadline to each task
- sort the tasks by priority and status mark

Creating the To Do List

1. Press the **New** soft key.
2. Enter the first task.

Note: You can enter up to 40 characters. For further details on how to enter characters, see page 43.
3. Press the **OK** soft key.
4. Select high, normal or low priority using the **▲** or **▼** key and press the **Select** soft key.
5. Enter your deadline.

If you do not want to set a deadline, press the **Skip** soft key.

6. Press the **OK** soft key.

Editing the To Do List

If tasks are already defined in the To Do List when you select the **To Do List** menu option (**Menu 7.2**), the current contents are displayed with a status mark and priority (🔴 for high, 🟡 for normal and 🟢 for low).

The following options are available:

| To... | Then... |
|--------------------------------------|--|
| view the details for a specific task | <ul style="list-style-type: none"> • highlight the task. • press the View soft key. |
| change the status of a specific task | <ul style="list-style-type: none"> • highlight the task. • press the  key to mark the task as completed as of the current date and time. <p>or</p> <ul style="list-style-type: none"> • highlight the task. • press the Options soft key. • select the Mark option. • select the appropriate status (Done or Undo). |
| create a new task | <ul style="list-style-type: none"> • press the Options soft key. • select the New option. • enter text, priority and deadline for the task. |
| edit an existing task | <ul style="list-style-type: none"> • highlight the task. • press the Options soft key. • select the Edit option. • change the text, priority and deadline for the task. |

| To... | Then... |
|---|---|
| sort the existing tasks by priority or status | <ul style="list-style-type: none"> press the Options soft key. select the Sort option. select the sort criterion (High, Low, Done or Undo). |
| copy a task | <ul style="list-style-type: none"> highlight the task. press the Options soft key. select the Copy option. change the text, priority and deadline for the task as required. |
| copy a task to the calendar | <ul style="list-style-type: none"> highlight the task. press the Options soft key. select the Copy to calendar option. change the text and deadline for the task and set the alarm as required. |
| delete a task | <ul style="list-style-type: none"> highlight the task. press the Options soft key. select the Delete option. |
| delete all tasks | <ul style="list-style-type: none"> press the Options soft key. select the Delete all option. confirm the deletion by pressing OK. |
| exit the To Do list | <ul style="list-style-type: none"> press the Options soft key. select the Exit option. |

Time & Date *(Menu 7.3)*

This option allows you to change the current time and date displayed. You can also check the current time for Greenwich Mean Time (GMT) and 21 major cities around the world.

The following options are available:

Set Time: allows you to enter the current time. You can choose the time format via the **Time Format** menu option (**Menu 7.3.4**).

Note: Before setting the time, you must specify your time zone, in the **World Time** menu option (**Menu 7.3.3**).

Set Date: allows you to enter the day, month and year.

World Time: allows you to check the current time for Greenwich Mean Time (GMT) and 21 major cities around the world, using the **(** and **)** keys.

The screen shows the:

- city name
- current date and time
- time difference between the selected city and your city if you have set the local time (see below for further details)

To select your time zone:

- Select the city corresponding to your time zone by pressing the **(** or **)** key one or more times. The local date and time display.
- Press the **Set** soft key.

Time Format: allows you to change the time format to **24 Hours** or **12 Hours**.

Alarm *(Menu 7.4)*

This feature allows you to:

- set the alarm to ring at a specific time
- set the phone to switch on automatically and ring the alarm even if the phone is switched off (**Autopower** menu option set to **Enable**)

The following options are available:

Once Alarm: the alarm rings only once and is then deactivated.

Daily Alarm: the alarm rings every day at the same time.

Morning Call: the alarm rings to wake you up in the morning.

To set the alarm:

1. Choose the type of alarm to be set.
2. Enter the required time and day of the week, if applicable.
3. Press the **OK** soft key.
4. If you select **Morning Call** in Step 1, select the repeat option; **Monday to Friday** or **Monday to Saturday**.

Remove Alarm: deactivates all alarm settings.

Autopower: if this option is set to **Enable**, the alarm will ring at the specified time, even when the phone is switched off.

If the menu option is set to **Disable** and the phone is switched off at the specified time, the alarm will not ring.

To stop the alarm when it rings, open the folder and press the **Exit** soft key.

When setting or viewing an alarm, the following options are available when you press the **Options** soft key:

Remove Alarm: deactivates the current alarm.

Alarm Sound Set: allows you to select the alarm melody.



Calculator *(Menu 7.5)*

With this feature, you can use the phone as a calculator. The calculator provides the basic arithmetic functions: addition, subtraction, multiplication and division.

Using the Calculator

1. Enter the first number using the numeric keys.
2. Press the right soft key until the required arithmetic symbol appears: + (add), - (subtract), * (multiply), / (divide).
3. Enter the second number.
4. Repeat Steps 1 to 3 as many times as required.

Notes:

- To erase any mistakes or clear the display, press the  key.
 - To include a decimal point or a bracket, press the left soft key until the required symbol is displayed.
5. To calculate the result, press the  key.

Currency Exchange *(Menu 7.6)*

Using this menu option, you can make currency conversions.

1. Enter the current exchange rate of your source currency and press the **OK** soft key.

You can insert a decimal point by pressing the  key.

2. Enter the amount for which you wish to conduct the currency conversion and press the **OK** soft key.

The exchange rate amount you entered and equivalent value display.

3. Press the **Exit** soft key to exit the currency convertor.

Network Services

These menu functions are network services. Please contact your service provider to check their availability and subscribe to them, if you wish.

Call Forwarding *(Menu 8.1)*

This network service enables incoming calls to be rerouted to the number that you specify.

Example: You may wish to forward your business calls to a colleague while you are on holiday.

Call forwarding can be set up in the following ways:

Forward Always: all calls are forwarded.

Busy: calls are forwarded if you are already making another call.

No Reply: calls are forwarded if you do not answer the phone.

Unreachable: calls are forwarded if you are not in an area covered by your service provider.

Cancel All: all call forwarding options are canceled.

You can specify individual forwarding options for each of the following call types:

- Voice calls only
- Data calls only

Example: You can forward voice calls to your colleague if you are already using the phone.

To set your call forwarding options:

4. Select the type of call forwarding required by pressing the **▲** or **▼** key, and then press the **Select** soft key.
5. Select the type of calls to be forwarded by pressing the **▲** or **▼** key, and then press the **Select** soft key.

The current status is displayed. If the option has already been set, the number to which the calls are forwarded is displayed.

- | | |
|----------------------------|--|
| 3. To... | Press the... |
| activate call forwarding | Activate soft key. Go to Step 4. |
| change the call number | Change soft key. Go to Step 4. |
| deactivate call forwarding | Remove soft key. |

4. Enter the number to which the calls are to be forwarded and press **OK**.
To enter an international code, press the  key until the + sign is displayed.

The phone sends your settings to the network and the network's acknowledgement is displayed.

You can deactivate all call forwarding settings by selecting the **Cancel All** option.

Call Waiting *(Menu 8.2)*

This network service enables you to be informed when someone is trying to reach you during another call.

You can specify individual call waiting options for each of the following call types:

- Voice calls only
- Data calls only

To set your call waiting options:

1. Select the type of calls to which the call waiting option is to be applied by pressing the **▲** or **▼** key, and then press the **Select** soft key.

The screen informs you whether call waiting is activated or deactivated.

2. You can activate or deactivate the call waiting feature as necessary by using the **Activate** or **Deactivate** soft key respectively.

To return to the previous screen, press the **Exit** soft key.

You can also deactivate all call waiting settings by selecting the **Cancel All** option.

Network Selection *(Menu 8.3)*

The Network Selection feature enables you to automatically or manually select the network used when roaming (outside your home area).

Note: You can select a network other than your home network only if it has a valid roaming agreement with your home network.

1. When **Network Selection** is displayed, press the **Select** soft key.
2. Press the **▲** or **▼** key until the appropriate option is highlighted and then press the **OK** soft key.

If you select **Automatic**, you are connected to the first available network when roaming.

If you select **Manual**, the phone scans for the available networks. Go to Step 3.

3. Press the **▲** or **▼** key until the preferred network is highlighted and then press the **OK** soft key.

You are connected to that network.

Caller ID *(Menu 8.4)*

You can prevent your phone number from being displayed on the phone of the person being called.

Note: Some networks do not allow the user to change this setting.

The following options are available:

Default: the default setting provided by the network is used.

Hide Number: your number is not displayed on the other person's phone.

Send Number: your number is sent each time you make a call.

Band Selection *(Menu 8.5)*

For the phone to make and receive phone calls, it must register with one of the available networks. Your phone can handle any of the following types of network:

- Combined GSM 900/1800
- GSM 1900

The country where you purchased your phone determines the default band that it uses. When you travel abroad, you must remember to change to an appropriate band. Proceed as follows.

1. When **Band Selection** is displayed, press the **Select** soft key.
2. Press the **▲** or **▼** key until the appropriate option, **GSM 900/1800** or **GSM 1900**, is highlighted and press the **OK** soft key.

When you select a new band, your phone displays a confirmation message and then automatically searches for all the available networks. Your phone then registers with a preferred network within the selected band.



Funbox

The **Funbox** menu contains several fun options.

Games *(Menu 9.1)*

You can enjoy three games with your phone.

Scroll to the required game, using the **▲** and **▼** keys and press the **Select** soft key. For further details on the game, refer to the on-screen help.

T-Zones *(Menu 9.2)*

Your phone is equipped with a WAP (Wireless Application Protocol) Browser to allow you to access and navigate the Wireless Web via your phone. In this menu, you can use the WAP browser.

For further details on the WAP browser, refer to the WAP Browser User's Manual supplied with your phone.

Downloads *(Menu 9.3)*

Sounds

In this menu, you can view the list of sounds downloaded from the server. You can set the downloaded sounds as the current ring tone, but cannot send the sounds to other phones.

When the memory is full, a warning message is displayed and the phone rejects additional sounds until you erase obsolete ones.

Pictures

In this menu, you can view the list of pictures downloaded from the server. You can set the downloaded pictures as the current background image, but cannot send them to other phones.

When the memory is full, a warning message is displayed and the phone rejects additional pictures until you erase obsolete ones.

Solving Problems

Before contacting the after-sales service, perform the following simple checks. They may save you the time and expense of an unnecessary service call.

When you switch your phone on, the following messages may appear

Insert SIM Card

- Check that the SIM card is correctly installed.

Phone Locked Enter Password

- The automatic locking function has been enabled. You must enter the phone's password before you can use the phone.

Enter PIN

- You are using your phone for the first time. You must enter the Personal Identification Number supplied with the SIM card.
- The PIN Check feature is enabled. Every time the phone is switched on, the PIN has to be entered. To disable this feature, use the **PIN Check** menu option (**Menu 6.6.1**).

Enter PUK

- The PIN code was entered incorrectly three times in succession and the phone is now blocked. Enter the PUK supplied by your network operator.

“No service,” “Network failure” or “Not done” is displayed

- The network connection was lost. You may be in a weak signal area (in a tunnel or surrounded by buildings). Move and try again.
- You are trying to access an option for which you have not taken out a subscription with your service provider. Contact the service provider for further details.

You have entered a number but it was not dialed

- Have you pressed the  key?
- Are you accessing the right cellular network?
- You may have set an outgoing call barring option.

Your correspondent cannot reach you

- Is your phone switched on (the  key pressed for more than one second)?
- Are you accessing the right cellular network?
- You may have set an incoming call barring option.



Your correspondent cannot hear you speaking

- Have you switched off the microphone?
- Are you holding the phone close enough to your mouth? The microphone is located at the bottom of the phone.

The phone starts beeping and “Warning** Low Battery” flashes on the display**

- The battery is insufficiently charged. Replace the battery and recharge it.

The audio quality of the call is poor

- Check the signal strength indicator on the display (); the number of bars indicates the signal strength from strong () to weak ().
- Try moving the phone slightly or moving closer to a window if you are in a building.

No number is dialed when you recall a Phonebook entry

- Check that the number has been stored correctly, by using the Phonebook Search feature.
- Re-store the number, if necessary.

If the above guidelines do not help you to solve the problem, take a note of:

- the model and serial numbers of your phone
- your warranty details
- a clear description of the problem

Then contact your local dealer or Samsung after-sales service.

Access Codes

There are several access codes that are used by your phone and its SIM card. These codes help you protect the phone against unauthorized use.

When requested for any of the codes explained below, key in the appropriate code (displayed as asterisks) and press the **OK** soft key. If you make a mistake, press the  key until the incorrect digit is cleared and then continue entering the correct code.

The access codes, except for the PUK and PUK2 codes can be changed using **Security** menu options (**Menu 6.6**). See page 91 for further details.

Important! Avoid using access codes resembling emergency numbers, such as 911, so that you do not dial an emergency number accidentally.

Phone Password

The Phone Lock feature uses the phone password to protect your phone against unauthorized use. The phone password is supplied with the phone and is factory set to "00000000."

| To... | Refer to... |
|--|-----------------------------------|
| activate/deactivate the Phone Lock feature | page 92 (Menu 6.6.3). |
| change the phone password | page 92 (Menu 6.6.4). |

PIN

The **Personal Identification Number** or PIN (4 to 8 digits) protects your SIM card against unauthorized use. It is usually supplied with the SIM card.

If you enter an incorrect PIN three times in succession, the code is disabled and cannot be used until you re-enable it by entering the PUK (see below).

| To... | Refer to... |
|---|-----------------------------------|
| activate/deactivate the PIN Check feature | page 91 (Menu 6.6.1). |
| change the PIN | page 92 (Menu 6.6.2). |

PUK

The 8-digit PUK (**PIN Unblocking Key**) is required to change a disabled PIN. The PUK may be supplied with the SIM card. If not, or you have lost it, contact your service provider.

To re-enable your PIN:

1. Key in the PUK and press the **OK** soft key.
2. Enter a new PIN of your choice and press the **OK** soft key.
3. When the **Confirm New PIN** message is displayed, key in the same code again and press the **OK** soft key.

If you enter an incorrect PUK ten times in succession, the SIM card becomes invalid. Contact your service provider for a new card.

PIN2

The PIN2 (4 to 8 digits), supplied with some SIM cards, is required to access specific functions, such as setting the maximum cost of a call. These functions are available if supported by your SIM card.

If you enter an incorrect PIN2 three times in succession, the code is disabled and you cannot access the functions until you re-enable it by entering the PUK2.

To change the PIN2, refer to page 93 (**Menu 6.6.6**).

PUK2

The 8-digit PUK2 (**PIN Unblocking Key 2**), supplied with some SIM cards, is required to change a disabled PIN2. If you lose the code, contact your service provider.

To re-enable your PIN2:

1. Key in the PUK2 and press the **OK** soft key.
2. Enter a new PIN2 of your choice and press the **OK** soft key.
3. When the **Confirm PIN2** message is displayed, key in the same code again and press the **OK** soft key.

If you enter an incorrect PUK2 ten times in succession, you will not be able to access the functions requiring the PIN2. Contact your service provider for a new card.

Health and Safety Information

Exposure to Radio Frequency (RF) Signals

Your wireless phone is a radio transmitter and receiver. It is designed and manufactured not to exceed the emission limits for exposure to radio frequency (RF) energy set by the Federal Communications Commission (FCC) of the U.S. Government. These limits are part of comprehensive guidelines and establish permitted levels of RF energy for the general population. The guidelines are based on the safety standards previously set by both U.S. and international standards bodies:

- American National Standards Institute (ANSI) IEEE. C95.1-1992
- National Council on Radiation Protection and Measurement (NCRP). Report 86. 1986
- International Commission on Non-Ionizing Radiation Protection (ICNIRP) 1996
- Ministry of Health (Canada), Safety Code 6.

The standards include a substantial safety margin designed to assure the safety of all persons, regardless of age and health.

The exposure standard for wireless phones employs a unit of measurement known as Specific Absorption Rate (SAR). The SAR limit recommended by the FCC is 1.6W/kg.*

* In the U.S. and Canada, the SAR limit for mobile phones used by the public is 1.6 watts/kg (W/kg) averaged over one gram of tissue. The standard incorporates a substantial margin of safety to give additional protection for the public and to account for any variations in measurements.

SAR tests are conducted using standard operating positions specified by the FCC with the phone transmitting at its highest certified power level in all tested frequency bands. Although the SAR is determined at the highest certified power level, the actual SAR level of the phone while operating can be well below the maximum value. This is because the phone is designed to operate at multiple power levels so as to use only the power required to reach the network. In general, the closer you are to a wireless base station antenna, the lower the power output of the phone.

Before a phone model is available for sale to the public, it must be tested and certified to the FCC that it does not exceed the limit established by the government-adopted requirement for safe exposure. The tests are performed in positions and locations (e.g., at the ear and worn on the body) as required by the FCC for each model. The highest SAR value for this model phone when tested for use at the ear is 0.971W/Kg and when worn on the body, as described in this user guide, is 0.245W/Kg (Body-worn measurements differ among phone models, depending upon available accessories and FCC requirements). While there may be differences between the SAR levels of various phones and at various positions, they all meet the government requirement for safe exposure.

The FCC has granted an Equipment Authorization for this model phone with all reported SAR levels evaluated as in compliance with the FCC RF emission guidelines. SAR information on this model phone is on file with the FCC and can be found under the Display Grant section of <http://www.fcc.gov/oet/fccid> after searching on FCC ID A3LSGHV205.

For body worn operation, to maintain compliance with FCC RF exposure guidelines, use only Samsung- approved accessories. When carrying the phone while it is on, use the specific Samsung-supplied or approved carrying case, holster, or other body-worn accessory.

Use of non-Samsung-approved accessories may violate FCC RF exposure guidelines and should be avoided.

For additional information concerning exposure to radio frequency signals, see the following websites:

Federal Communications Commission (FCC)

RF Safety program (select "Information on Human Exposure to RF Fields from Cellular and PCS Radio Transmitters"):

<http://www.fcc.gov/oet/rfsafety>

Cellular Telecommunications Industry

Association (CTIA): <http://www.wow-com.com>

World Health Organization (WHO)

International Commission on Non-Ionizing Radiation Protection (select Qs & As):

<http://www.who.int/emf>

United Kingdom, National Radiological Protection Board: <http://www.nrpb.org.uk>

U.S. Food and Drug Administration (FDA)

Center for Devices and Radiological Health:
<http://www.fda.gov/cdrh/consumer/>

Precautions When Using Batteries

- Never use any charger or battery that is damaged in any way.
- Use the battery only for its intended purpose.
- If you use the phone near the network's base station, it uses less power; talk and standby time are greatly affected by the signal strength on the cellular network and the parameters set by the network operator.
- Battery charging time depends on the remaining battery charge and the type of battery and charger used. The battery can be charged and discharged hundreds of times, but it will gradually wear out. When the operation time (talk time and standby time) is noticeably shorter than normal, it is time to buy a new battery.
- If left unused, a fully charged battery will discharge itself over time.
- Use only Samsung-approved batteries and recharge your battery only with Samsung-approved chargers. When a charger is not in use, disconnect it from the power source. Do not leave the battery connected to a charger for more than a week, since overcharging may shorten its life.
- Extreme temperatures will affect the charging capacity of your battery: it may require cooling or warming first.
- Do not leave the battery in hot or cold places, such as in a car in summer or winter conditions, as you will reduce the capacity and lifetime of the battery. Always try to keep the battery at room temperature. A phone with a hot or cold battery may temporarily not work, even when the battery is fully charged. Li-ion batteries are particularly affected by temperatures below 0 °C (32 °F).
- Do not short-circuit the battery. Accidental short-circuiting can occur when a metallic object (coin, clip or pen) causes a direct connection between the + and – terminals of the battery (metal strips on the battery), for example when you carry a spare battery in a pocket or bag. Short-circuiting the terminals may damage the battery or the object causing the short-circuiting.
- Dispose of used batteries in accordance with local regulations. Always recycle. Do not dispose of batteries in a fire.

Road Safety

Your wireless phone gives you the powerful ability to communicate by voice, almost anywhere, anytime. But an important responsibility accompanies the benefits of wireless phones, one that every user must uphold.

When driving a car, driving is your first responsibility. When using your wireless phone behind the wheel of a car, practice good common sense and remember the following tips:

1. Get to know your wireless phone and its features, such as speed dial and redial. If available, these features help you to place your call without taking your attention off the road.
2. When available, use a hands-free device. If possible, add an extra layer of convenience and safety to your wireless phone with one of the many hands-free accessories available today.
3. Position your wireless phone within easy reach. Be able to access your wireless phone without removing your eyes from the road. If you get an incoming call at an inconvenient time, let your voice mail answer it for you.
4. Let the person you are speaking with know you are driving; if necessary, suspend the call in heavy traffic or hazardous weather conditions. Rain, sleet, snow, ice and even heavy traffic can be hazardous.
5. Do not take notes or look up phone numbers while driving. Jotting down a To Do list or flipping through your Phonebook takes your attention away from your primary responsibility, driving safely.
6. Dial sensibly and assess the traffic; if possible, place calls when you are not moving or before pulling into traffic. Try to plan calls when your car will be stationary. If you need to make a call while moving, dial only a few numbers, check the road and your mirrors, then continue.
7. Do not engage in stressful or emotional conversations that may be distracting. Make the people with whom you are talking aware that you are driving and suspend conversations that have the potential to divert your attention from the road.
8. Use your wireless phone to call for help. Dial the emergency number in the case of fire, traffic accident or medical emergencies. Remember, it is a free call on your wireless phone!
9. Use your wireless phone to help others in emergencies. If you see a car accident, crime in progress or other serious emergency where lives are in danger, call the emergency number, as you would want others to do for you.
10. Call roadside assistance or a special non-emergency wireless assistance number when necessary. If you see a broken-down vehicle posing no serious hazard, a broken traffic signal, a minor traffic accident where no one appears injured, or a vehicle you know to be stolen, call roadside assistance or any other special non-emergency wireless number.

Operating Environment

Remember to follow any special regulations in force in any area and always switch off your phone whenever it is forbidden to use it, or when it may cause interference or danger.

When connecting the phone or any accessory to another device, read its user's guide for detailed safety instructions. Do not connect incompatible products.

As with other mobile radio transmitting equipment, users are advised that for the satisfactory operation of the equipment and for the safety of personnel, it is recommended that the equipment should only be used in the normal operating position (held to your ear with the antenna pointing over your shoulder).

Electronic Devices

Most modern electronic equipment is shielded from radio frequency (RF) signals. However, certain electronic equipment may not be shielded against the RF signals from your wireless phone. Consult the manufacturer to discuss alternatives.

Pacemakers

Pacemaker manufacturers recommend that a minimum distance of 15 cm (6 inches) be maintained between a wireless phone and a pacemaker to avoid potential interference with the pacemaker. These recommendations are consistent with the independent research and recommendations of Wireless Technology Research.

Persons with pacemakers:

- Should always keep the phone more than 15 cm (6 inches) from their pacemaker when the phone is switched on
- Should not carry the phone in a breast pocket
- Should use the ear opposite the pacemaker to minimize potential interference

If you have any reason to suspect that interference is taking place, switch off your phone immediately.

Hearing Aids

Some digital wireless phones may interfere with some hearing aids. In the event of such interference, you may wish to consult your hearing aid manufacturer to discuss alternatives.

Other Medical Devices

If you use any other personal medical devices, consult the manufacturer of your device to determine if it is adequately shielded from external RF energy. Your physician may be able to assist you in obtaining this information. Switch off your phone in health care facilities when any regulations posted in these areas instruct you to do so. Hospitals or health care facilities may be using equipment that could be sensitive to external RF energy.

Vehicles

RF signals may affect improperly installed or inadequately shielded electronic systems in motor vehicles. Check with the manufacturer or its representative regarding your vehicle.

You should also consult the manufacturer of any equipment that has been added to your vehicle.

Posted Facilities

Switch off your phone in any facility where posted notices require you to do so.

Potentially Explosive Atmospheres

Switch off your phone when in any area with a potentially explosive atmosphere and obey all signs and instructions. Sparks in such areas could cause an explosion or fire resulting in bodily injury or even death.

Users are advised to switch off the phone while at a refueling point (service station). Users are reminded of the need to observe restrictions on the use of radio equipment in fuel depots (fuel storage and distribution areas), chemical plants or where blasting operations are in progress.

Areas with a potentially explosive atmosphere are often but not always clearly marked. They include below deck on boats, chemical transfer or storage facilities, vehicles using liquefied petroleum gas (such as propane or butane), areas where the air contains chemicals or particles, such as grain, dust or metal powders, and any other area where you would normally be advised to turn off your vehicle engine.

Emergency Calls

This phone, like any wireless phone, operates using radio signals, wireless and landline networks as well as user-programmed functions, which cannot guarantee connection in all conditions. Therefore, you should never rely solely on any wireless phone for essential communications (medical emergencies, for example).

Remember, to make or receive any calls the phone must be switched on and in a service area with adequate signal strength. Emergency calls may not be possible on all wireless phone networks or when certain network services and/or phone features are in use. Check with local service providers.

To make an emergency call:

1. If the phone is not on, switch it on.
2. Key in the emergency number for your present location. Emergency numbers vary by location.
3. Press the  key.

If certain features are in use (call barring, for example), you may first need to deactivate those features before you can make an emergency call. Consult this document and your local cellular service provider.

When making an emergency call, remember to give all the necessary information as accurately as possible. Remember that your phone may be the only means of communication at the scene of an accident; do not cut off the call until given permission to do so.

Other Important Safety Information

- Only qualified personnel should service the phone or install the phone in a vehicle. Faulty installation or service may be dangerous and may invalidate any warranty applicable to the device.
- Check regularly that all wireless phone equipment in your vehicle is mounted and operating properly.
- Do not store or carry flammable liquids, gases or explosive materials in the same compartment as the phone, its parts or accessories.
- For vehicles equipped with an air bag, remember that an air bag inflates with great force. Do not place objects, including both installed or portable wireless equipment in the area over the air bag or in the air bag deployment area. If wireless equipment is improperly installed and the air bag inflates, serious injury could result.
- Switch off your phone before boarding an aircraft. The use of wireless phones in aircraft may be dangerous to the operation of the aircraft, and is illegal.
- Failure to observe these instructions may lead to the suspension or denial of telephone services to the offender, or legal action, or both.

Care and Maintenance

Your phone is a product of superior design and craftsmanship and should be treated with care. The suggestions below will help you fulfill any warranty obligations and allow you to enjoy this product for many years.

- Keep the phone and all its parts and accessories out of the reach of small children's.
- Keep the phone dry. Precipitation, humidity and liquids contain minerals that will corrode electronic circuits.
- Do not touch the phone with wet hands while it is charging. Doing so may give you an electric shock or damage the phone.
- Do not use or store the phone in dusty, dirty areas, as its moving parts may be damaged.
- Do not store the phone in hot areas. High temperatures can shorten the life of electronic devices, damage batteries, and warp or melt certain plastics.
- Do not store the phone in cold areas. When the phone warms up to its normal operating temperature, moisture can form inside the phone, which may damage the phone's electronic circuit boards.
- Do not drop, knock or shake the phone. Rough handling can break internal circuit boards.
- Do not use harsh chemicals, cleaning solvents or strong detergents to clean the phone. Wipe it with a soft cloth slightly dampened in a mild soap-and-water solution.

- Do not paint the phone. Paint can clog the device's moving parts and prevent proper operation.
- Do not put the phone in or on heating devices, such as a microwave oven, a stove or a radiator. The phone may explode when overheated.
- Use only the supplied or an approved replacement antenna. Unauthorized antennas or modified accessories may damage the phone and violate regulations governing radio devices.
- If the phone, battery, charger or any accessory is not working properly, take it to your nearest qualified service facility. The personnel there will assist you, and if necessary, arrange for service.

IMPORTANT SAFETY INSTRUCTIONS - SAVE THESE INSTRUCTIONS.

DANGER- TO REDUCE THE RISK OF FIRE OR ELECTRIC SHOCK, CAREFULLY FOLLOW THESE INSTRUCTIONS.

FOR CONNECTION TO A SUPPLY NOT IN THE U.S. A., USE AN ATTACHMENT PLUG ADAPTOR OF THE PROPER CONFIGURATION FOR THE POWER OUTLET.

Acknowledging Special Precautions and the FCC and Industry Canada Notice

Cautions

Modifications not expressly approved by the party responsible for compliance could void the user's authority to operate the equipment.

FCC Compliance Information

This device complies with Part 15 of FCC Rules. Operation is subject to the following two conditions:

1. This device may not cause harmful interference, and
2. This device must accept any interference received.

Including interference that may cause undesired operation.

Information to User

This equipment has been tested and found to comply with the limits for a Class B digital device, pursuant to part 15 of the FCC Rules. These limits are designed to provide reasonable protection against harmful interference in a residential installation.

This equipment generates, uses and can radiate radio frequency energy and, if not installed and used in accordance with the instructions, may cause harmful interference to radio communications.

However, there is no guarantee that interference will not occur in a particular installation. If this equipment does cause harmful interference to radio or television reception, which can be determined by turning the equipment off and on, the user is encouraged to try to correct the interference by one or more of the following measures:

- Reorient or relocate the receiving antenna.
- Increase the separation between the equipment and receiver.
- Connect the equipment into an outlet on a circuit different from that to which the receiver is connected.
- Consult the dealer or an experienced radio/ TV technician for help.

STANDARD LIMITED WARRANTY

What is Covered and For How Long? SAMSUNG TELECOMMUNICATIONS AMERICA, L.P. ("SAMSUNG") warrants to the original purchaser ("Purchaser") that SAMSUNG's Phones and accessories ("Products") are free from defects in material and workmanship under normal use and service for the period commencing upon the date of purchase and continuing for the following specified period of time after that date:

| | |
|-------------------------|---------|
| Phone | 1 Year |
| Batteries | 1 Year |
| Leather Case/ Pouch | 90 Days |
| Holster | 90 Days |
| Other Phone Accessories | 1 Year |

What is Not Covered? This Limited Warranty is conditioned upon proper use of Product by Purchaser. This Limited Warranty does not cover: (a) defects or damage resulting from accident, misuse, abuse, neglect, unusual physical, electrical or electromechanical stress, or modification of any part of Product, including antenna, or cosmetic damage; (b) equipment that has the serial number removed or made illegible; (c) any plastic surfaces or other externally exposed parts that are scratched or damaged due to normal use; (d) malfunctions resulting from the use of Product in conjunction with accessories, products, or ancillary/peripheral equipment not furnished or approved by SAMSUNG; (e) defects or damage from improper testing, operation, maintenance, installation, or adjustment; (f) installation, maintenance, and service of Product, or (g) Product used or purchased outside the United States or Canada. This Limited Warranty covers batteries only if battery capacity falls below 80% of rated capacity or the battery leaks, and this Limited Warranty does not cover any battery if (i) the battery has been charged by a battery charger not specified or approved by SAMSUNG for charging the battery, (ii) any of the seals on the battery are broken or show evidence of tampering, or (iii) the battery has been used in equipment other than the SAMSUNG phone for which it is specified.

What are SAMSUNG's Obligations? During the applicable warranty period, SAMSUNG will repair or replace, at SAMSUNG's sole option, without charge to Purchaser, any defective component part of Product. To obtain service under this Limited Warranty, Purchaser must return Product to an authorized phone service facility in an adequate container for shipping, accompanied by Purchaser's sales receipt or comparable substitute proof of sale showing the date of purchase, the serial number of Product and the sellers' name and address. To obtain assistance on where to deliver the Product, call Samsung Customer Care at 1-888-987-4357. Upon receipt, SAMSUNG will promptly repair or replace the defective Product. SAMSUNG may, at SAMSUNG's sole option, use rebuilt, reconditioned, or new parts or components when repairing any Product or replace

Product with a rebuilt, reconditioned or new Product. Repaired/replaced leather cases, pouches and holsters will be warranted for a period of ninety (90) days. All other repaired/replaced Product will be warranted for a period equal to the remainder of the original Limited Warranty on the original Product or for 90 days, whichever is longer. All replaced parts, components, boards and equipment shall become the property of SAMSUNG. If SAMSUNG determines that any Product is not covered by this Limited Warranty, Purchaser must pay all parts, shipping, and labor charges for the repair or return of such Product.

What Are the Limits On SAMSUNG's Liability? EXCEPT AS SET FORTH IN THE EXPRESS WARRANTY CONTAINED HEREIN, PURCHASER TAKES THE PRODUCT "AS IS," AND SAMSUNG MAKES NO WARRANTY OR REPRESENTATION AND THERE ARE NO CONDITIONS, EXPRESS OR IMPLIED, STATUTORY OR OTHERWISE, OF ANY KIND WHATSOEVER WITH RESPECT TO THE PRODUCT, INCLUDING BUT NOT LIMITED TO:

- THE MERCHANTABILITY OF THE PRODUCT OR ITS FITNESS FOR ANY PARTICULAR PURPOSE OR USE;
- WARRANTIES OF TITLE OR NON-INFRINGEMENT;
- DESIGN, CONDITION, QUALITY, OR PERFORMANCE OF THE PRODUCT;
- THE WORKMANSHIP OF THE PRODUCT OR THE COMPONENTS CONTAINED THEREIN; OR
- COMPLIANCE OF THE PRODUCT WITH THE REQUIREMENTS OF ANY LAW, RULE, SPECIFICATION OR CONTRACT PERTAINING THERETO.

NOTHING CONTAINED IN THE INSTRUCTION MANUAL SHALL BE CONSTRUED TO CREATE AN EXPRESS WARRANTY OF ANY KIND WHATSOEVER WITH RESPECT TO THE PRODUCT. ALL IMPLIED WARRANTIES AND CONDITIONS THAT MAY ARISE BY OPERATION OF LAW, INCLUDING IF APPLICABLE THE IMPLIED WARRANTIES OF MERCHANTABILITY AND FITNESS FOR A PARTICULAR PURPOSE, ARE HEREBY LIMITED TO THE SAME DURATION OF TIME AS THE EXPRESS WRITTEN WARRANTY STATED HEREIN. SOME STATES/PROVINCES DO NOT ALLOW LIMITATIONS ON HOW LONG AN IMPLIED WARRANTY LASTS, SO THE ABOVE LIMITATION MAY NOT APPLY TO YOU. IN ADDITION, SAMSUNG SHALL NOT BE LIABLE FOR ANY DAMAGES OF ANY KIND RESULTING FROM THE PURCHASE, USE, OR MISUSE OF, OR INABILITY TO USE THE PRODUCT OR ARISING DIRECTLY OR INDIRECTLY FROM THE USE OR LOSS OF USE OF THE PRODUCT OR FROM THE BREACH OF THE EXPRESS WARRANTY, INCLUDING INCIDENTAL, SPECIAL, CONSEQUENTIAL OR SIMILAR DAMAGES, OR LOSS OF ANTICIPATED PROFITS OR BENEFITS, OR FOR DAMAGES ARISING FROM ANY TORT (INCLUDING NEGLIGENCE OR GROSS NEGLIGENCE) OR FAULT COMMITTED BY SAMSUNG, ITS AGENTS OR EMPLOYEES, OR FOR ANY BREACH OF CONTRACT OR FOR ANY CLAIM BROUGHT AGAINST PURCHASER BY ANY OTHER PARTY. SOME STATES/PROVINCES DO NOT ALLOW THE EXCLUSION OR LIMITATION OF INCIDENTAL OR

CONSEQUENTIAL DAMAGES, SO THE ABOVE LIMITATION OR EXCLUSION MAY NOT APPLY TO YOU.

THIS WARRANTY GIVES YOU SPECIFIC LEGAL RIGHTS, AND YOU MAY ALSO HAVE OTHER RIGHTS, WHICH VARY FROM STATE TO STATE/PROVINCE TO PROVINCE. THIS LIMITED WARRANTY SHALL NOT EXTEND TO ANYONE OTHER THAN THE ORIGINAL PURCHASER OF THIS PRODUCT AND STATES PURCHASER'S EXCLUSIVE REMEDY. IF ANY PORTION OF THIS LIMITED WARRANTY IS HELD ILLEGAL OR UNENFORCEABLE BY REASON OF ANY LAW, SUCH PARTIAL ILLEGALITY OR UNENFORCEABILITY SHALL NOT AFFECT THE ENFORCEABILITY FOR THE REMAINDER OF THIS LIMITED WARRANTY WHICH PURCHASER ACKNOWLEDGES IS AND WILL ALWAYS BE CONSTRUED TO BE LIMITED BY ITS TERMS OR AS LIMITED AS THE LAW PERMITS.

THE PARTIES UNDERSTAND THAT THE PURCHASER MAY USE THIRD-PARTY SOFTWARE OR EQUIPMENT IN CONJUNCTION WITH THE PRODUCT. SAMSUNG MAKES NO WARRANTIES OR REPRESENTATIONS AND THERE ARE NO CONDITIONS, EXPRESS OR IMPLIED, STATUTORY OR OTHERWISE, AS TO THE QUALITY, CAPABILITIES, OPERATIONS, PERFORMANCE OR SUITABILITY OF ANY THIRD-PARTY SOFTWARE OR EQUIPMENT, WHETHER SUCH THIRD-PARTY SOFTWARE OR EQUIPMENT IS INCLUDED WITH THE PRODUCT DISTRIBUTED BY SAMSUNG OR OTHERWISE, INCLUDING THE ABILITY TO INTEGRATE ANY SUCH SOFTWARE OR EQUIPMENT WITH THE PRODUCT. THE QUALITY, CAPABILITIES, OPERATIONS, PERFORMANCE AND SUITABILITY OF ANY SUCH THIRD-PARTY SOFTWARE OR EQUIPMENT LIE SOLELY WITH THE PURCHASER AND THE DIRECT VENDOR, OWNER OR SUPPLIER OF SUCH THIRD-PARTY SOFTWARE OR EQUIPMENT, AS THE CASE MAY BE.

This Limited Warranty allocates risk of Product failure between Purchaser and SAMSUNG, and SAMSUNG's Product pricing reflects this allocation of risk and the limitations of liability contained in this Limited Warranty. The agents, employees, distributors, and dealers of SAMSUNG are not authorized to make modifications to this Limited Warranty, or make additional warranties binding on SAMSUNG. Accordingly, additional statements such as dealer advertising or presentation, whether oral or written, do not constitute warranties by SAMSUNG and should not be relied upon.

Samsung Telecommunications America, L.P.
1130 East Arapaho Road
Richardson, Texas 75081
Phone: 1-800-SAMSUNG
Phone: 1-888-987-HELP (4357)

©2002 Samsung Telecommunications America. All rights reserved.

No reproduction in whole or in part allowed without prior written approval.

Specifications and availability subject to change without notice. [080802]

Glossary

To help you understand the main technical terms and abbreviations used in this booklet and take full advantage of the features on your mobile phone, here are a few definitions.

Active Flip

Ability to answer a call simply by opening the phone.

Call Forwarding

Ability to reroute calls to another number.

Call Holding

Ability to put one call on standby while answering or making another call; you can then switch between the two calls, as required.

Call Waiting

Ability to inform users that they have an incoming call when engaged on another call.

GSM (Global System for Mobile Communication)

International standard for cellular communication, guaranteeing compatibility between the various network operators. GSM covers most European countries and many other parts of the world.

Line Identification Services (Caller ID)

Services allowing subscribers to view or block the telephone numbers of callers.

MMS (Multimedia Message Service)

A message service for the mobile environment, standardized by the WAP Forum and the 3rd Generation Partnership Program (3GPP). For phone users, MMS is similar to Short Message Service (SMS)-it provides automatic, immediate delivery of user-created content from phone to phone. The message addressing used is primarily phone numbers, thus the traffic goes from phone to phone. MMS also provides support for e-mail addressing, so that messages can also be sent by e-mail. In addition to the text content of SMS, MMS messages can contain still images, voice or audio clips, and later also video clips and presentation information.

Multiparty Calling

Ability to establish a conference call involving up to five additional parties.

Phone Password

Security code used to unlock the phone when you have selected the option to lock it automatically each time it switches on.

PIN (Personal Identification Number)

Security code that protects the phone/SIM against unauthorized use. The PIN is supplied by the service provider with the SIM card. It may be a four to eight-digit number and can be changed, as required.

PUK (PIN Unblocking Key)

Security code used to unlock the phone when an incorrect PIN has been entered three times in succession. The eight-digit number is supplied by the service provider with the SIM card.

Roaming

Use of your phone when you are outside your home area (when traveling for example).

SDN (Service Dialing Numbers)

Telephone numbers supplied by your network provider and giving access to special services, such as voice mail, directory inquiries, customer support and emergency services.



SIM (Subscriber Identification Module)

Card containing a chip with all the information required to operate the phone (network and memory information, as well as the subscriber's personal data). The SIM card fits into a small slot on the back of the phone and is protected by the battery.

SMS (Short Message Service)

Network service sending and receiving messages to and from another subscriber without having to speak to the correspondent. The message created or received can be displayed, received, edited or sent.

Soft Keys

Two keys marked  and  on the phone, the purpose of which:

- varies according to the function that you are currently using
- is indicated on the bottom line of the display just above the corresponding key

Tri Band

Ability to handle any of the following types of network: GSM 900, GSM 1800, combined GSM 900/1800 and GSM 1900 MHz bands, for greater call success and wider roaming.

Your phone automatically searches for the last network used. If, for any reason, this network is unavailable, your phone will attempt to register with a different network.

Voice Mail

Computerized answering service that automatically answers your calls when you are not available, plays a greeting (optionally in your own voice) and records a message.

A

Access codes • 118
 Accessories • 9
 Active folder • 96
 Alarm, set (7.4) • 104
 Alert type (5.3) • 85
 Answering
 a call • 26
 a second call • 52
 Anykey answer • 96
 Auto light • 95
 Auto power, alarm • 104
 Auto redial (6.5) • 96

B

Background image • 89
 Backlight • 15, 94
 Band selection (8.5) • 112
 Battery
 charging • 19
 low battery indicator • 20
 precautions • 124
 Broadcast (1.9) • 70

C

Calculator (7.5) • 105
 Calendar (7.1) • 98
 Caller ID (8.4) • 111
 Calls
 answering
 a call • 26
 a second call • 52
 emergency • 131
 ending • 24
 forwarding (8.1) • 107
 holding • 49
 incoming (3.2) • 78
 international • 23
 making • 23
 missed • 27, 78
 multiparty • 53
 outgoing (3.3) • 79
 records (3) • 78

redialing automatically
 • 96
 time (3.4) • 79
 via phonebook • 38
 waiting (8.2) • 52, 109

Camera (4) • 81

Card

 installing the SIM • 17

Care • 133

Changing

 password (6.6.4) • 92

 PIN (6.6.2) • 92

 PIN2 (6.6.6) • 93

Characters

 changing mode • 44

 entering • 43

Charging battery • 19

Conference call • 53

Connect tone • 87

Contrast (6.7.1) • 94

Copying

 memos • 100

 phonebook number • 37

 task • 102

Correcting numbers • 23

Currency Exchange (7.6) • 106

D

Date setting (7.3.2) • 103

Deleting

 memos • 100

 messages • 62, 63

 missed calls • 28, 78

 phonebook number • 37

 tasks • 102

Display

 contrast • 94

 icons • 14

 layout • 13

 setting language • 91

Downloads (9.3) • 113

E

Earpiece volume • 25

Editing

 memos • 99

 messages • 62, 63

 missed calls • 27, 78

 phonebook number • 37

 tasks • 101

 to do list • 101

Emergency calls • 131

Error tone • 87

F

FDN mode (6.6.5) • 93

Fixed Dial Number mode • 93

Forwarding calls (8.1) • 107

Funbox (9) • 113

Functions, select • 30

G

Game (9.1) • 113

Greeting message (6.3) • 90

H

Holding calls • 49

I

Icons, description • 14

Identifying a caller • 26

Incoming calls (3.2) • 78

Incoming messages

 picture (2.1) • 72

 text (1.1) • 61

Infrared activate (6.1) • 88

Internet • 113

IrDA port • 88

K

Key tones

 adjusting volume • 25

 muting • 51

 selecting (5.4) • 85

 sending • 51

Keys

 description • 11

 location • 10

 shortcut • 97

L

Language (6.5) • 91

Last number, redial • 24

Length of calls • 79, 87

Letters

 changing mode • 44

 entering • 43

Light

 backlight • 15, 94

 service • 16, 95

Locking phone (6.6.3) • 92

Low battery indicator • 20

Lower-case characters

 entering • 46

M

Maintenance • 133

Memory status

 message (1.7) • 69

 phonebook • 42

Memos

 copying • 100

 deleting • 100

 editing • 99

 writing • 99

Menus

 accessing by scroll • 55

 accessing by shortcuts

 • 56

 list • 56

Message tone (5.5) • 86

Microphone, mute • 50

Minute minder • 87

Missed calls • 27, 78

Morning Call • 104

Multimedia message, view

 • 72

Multiparty calls

 dropping • 54

 making • 53

 private conversation

 • 53

Muting

 key tones • 51

 microphone • 50

My objects (1.6) • 68

N

Names

entering • 43
searching/dialing • 38
storing • 34

Network selection (8.3) • 110

Network services (8) • 107

Numbers

copying phonebook • 37
correcting • 23
erasing • 37
fixed dial • 93
own • 90
pasting phonebook • 36
searching/dialing • 38
storing • 34

O

Options, select • 30

Organizer (7) • 98

Outgoing calls (3.3) • 79

Outgoing messages

picture (2.2) • 74
text (1.2) • 62

Own number (6.4) • 90

P

Password, phone

changing • 92
code • 118

Phone

lock (6.6.3) • 92
password • 118
settings (6) • 88

Phonebook

copying • 37
editing • 37
erasing • 37
options • 36
pasting • 36
searching/dialing • 38
speed-dialing • 41

storing numbers/names
• 34

Photos, take • 81

Picture message

inbox (2.1) • 72
outbox (2.2) • 74
setup (2.5) • 77
write new (2.3) • 75

PIN

changing • 92
checking • 91
code • 119

PIN2

changing • 93
code • 120

Problem solving • 115

PUK • 119

PUK2 • 120

R

Read messages

multimedia (2.1) • 72
text (1.1) • 61

Redialing

automatically • 96
last number • 24

Reset setting (6.10) • 97

Ring

tone (5.1) • 84
type (6.3) • 85
volume (6.2) • 84

Roaming • 110

S

Safety

information • 121
precautions • 7

Schedule • 98

Searching in phonebook • 38

Security (6.6) • 91

Selecting functions/options
• 30

Sending

key tones • 51
messages • 64

Service light • 16, 95

Setting

alarm (7.4) • 104
date (7.3.2) • 103
language (6.5) • 91
time (7.3.1) • 103

Shortcut (6.9) • 97

Silent mode • 30

SIM card

installing • 17
locking • 93

SIM Lock (6.6.5) • 93

SMS

message icon • 61
setup • 67
using • 52, 61

Soft keys • 30

Solving problems • 115

Sound settings (5) • 84

Speed-dialing • 41

Switching on/off

microphone • 50
phone • 21

T

T9 mode • 45

Tasks

defining • 100
editing • 101

Templates (1.4) • 66

Text

changing mode • 44
entering • 43

Text messages

broadcast (1.9) • 70
inbox (1.1) • 61
outbox (1.2) • 62
setting (1.5) • 67
templates (1.4) • 66
write new (1.3) • 64

Time

call • 79
format (7.3.4) • 103
setting (7.3.1) • 103
world (7.3.3) • 103

To do list (7.2) • 100

Tone

connect • 87

error • 87

keypad • 85

message • 86

ring • 84

Travel adapter • 19

U

Unpacking • 9

Upper-case characters

entering • 46

V

Vibration • 85

Voice mail (1.8) • 69

Voice server • 69

Volume

adjusting • 25
selecting the ring • 84

W

Waiting call • 52, 109

WAP browser (9.2) • 113

World time (7.3.3) • 103





Writing memos • 99



Writing messages

picture (2.3) • 75
text (1.3) • 64

Tri Band SGH-V205 GPRS Telephone Quick Reference Card

Access the Menu Functions

- ① Press the **Menu** soft key.
- ② Scroll with the  and  keys through the list of the menus until you reach the required menu.
- ③ Press the **Select** soft key.
- ④ Scroll with the  and  keys through the list of the options until the required one is selected.
- ⑤ Press the **Select** soft key.

- Each of the two soft keys ( and ) perform the function indicated by the text above it (on the bottom line of the display).

Switch On/Off

Press and hold the  key.

Make a Call

- ① Key in the number.
- ② Press the  key.



End a Call

Briefly press the  key.



View Missed Calls







① Open the phone and press the **View** soft key.

Immediately After Missing Them

- ② Scroll with the  and  keys through the missed calls.
- ③ To return the call, press the  key.



| | |
|-----------------------|--|
| Answer a Call | Open the phone or Press the  key. |
| Adjust the Volume | Press the  or  key on the left side of the phone. |
| Choose the Alert Type | <ol style="list-style-type: none"> ① Select the Alert Type menu option (5.3). ② Select an option: <ul style="list-style-type: none"> • Light only • Melody • Vibration • Vibra+Melody ③ Press the Select soft key. |

| | |
|--------------------------------------|--|
| Store Numbers in the Phonebook | <ol style="list-style-type: none"> ① Key in the number. ② Press the Save soft key. ③ Select an icon for label. ④ Press the Select soft key. ⑤ Enter the name. ⑥ Press the OK soft key. ⑦ If necessary, change the memory. ⑧ Press the OK soft key. ⑨ Press  to return to idle mode. |
| Search for a Number in the Phonebook | <ol style="list-style-type: none"> ① Press the Ph.Book soft key. ② Select the Search option. ③ Enter the first few letters of the name. ④ To scroll through the names, press the  or  key. ⑤ Press the View soft key. ⑥ To scroll through the numbers, press the  or  key. ⑦ Press the  key to dial. |